

Direct/Residual Shear Apparatus



CONTENTS

Quick Start Guide	2	System Information	16
Unpacking		Firmware Version	16
Installation and Equipment Setup	2	IP Information	16
Electrical Connections	2	Local Status	16
Power Switch	2	Internet Status	17
Air Connection	3	Memory	17
Instrumentation Connections and Setup	3	Factory Screen	17
HM-5760 Rear Instrumentation Panel	3	Export Log File	17
Network	3	Initial Set Up — Contact	17
USB Power	3	Contact Information	17
Instrument Inputs	3	Initial Set Up — Update	18
Initial Machine Set-up	4	Update from USB	19
Calibration Input Screen	6	Check for Update	20
Units	7	Update Details	20
Value	7	Download Updates	20
Export Calibration via USB	8	Equipment Setup	21
Initial Set Up — Date/Time	8	Installation and Equipment Setup	22
Date	9	Electrical Connections	22
Time	9	Power Switch	22
Clock Style	9	Air Connections	22
Clock	9	Air Connection Accessories	23
Initial Set Up — Display	9	Air Connection Accessories	24
Brightness	10	Instrumentation Connections and Setup	25
Dim Display	10	Rear Instrumentation Panel	25
Turn Display Off	10	Network	25
Preferences	10	USB Power	25
Preferences	10	Instrument Inputs	25
Preferences – General Tab	11	Test Deck Setup	26
Logger ID	11	Shearbox Assembly	27
Sound	11	Shearbox Replacement Screws	27
Automatically Update System	11	Sample Prep	28
Update Check Frequency	11	Shearbox Placement	28
Preferences – System Units Tab	11	Calibration of Instrumentation	30
Ambient Temperature	12	How to Perform a Calibration	30
Motor Speed Unit	12	Export Calibration via USB	30
Stress Control Unit	12	Test Setup	37
Preferences – Specimen Parameters Tab	12	Test Setup — Consolidation	38
Specimen Height	13	Test Setup Wizard – Select Test Type	38
Specimen Diameter	13	Template	38
Specimen Width	13	Test Setup Wizard – Select Target Load	39
Preferences – Storage Tab	13	Test Setup Wizard – Select Logging Values	40
Test Storage Limit	13	Test Setup Wizard – Select Stop Parameters	42
Recycled Tests	13	Test Setup Wizard – Select Trigger Parameters	43
Test Templates	13	Test Setup — Direct Shear	47
Initial Set Up — Network	14	Test Setup Wizard – Select Test Type	47
DHCP		Template	47
15		Test Setup Wizard – Select Motor Condition	48
IP Information	15	Test Setup Wizard – Select Logging Parameters	49
Local Status	15	Test Setup Wizard – Select Stop Condition	50
Internet Status	15	Test Setup Wizard – Graph Conditions	51
Initial Set Up — Information	15		

Unpacking

Initial inspection should include checking for physical damage during shipping and obvious external damage to the product.

Package contents are defined by your packing list. Each Loader is configured according to customer specifications. In your inspection, make certain that the contents of your shipment match the documentation provided by your packing list.

Place unit on a flat, smooth surface and use leveling feet (supplied) and a bubble level to ensure that the unit is level side-to-side and back-to-front.

Installation and Equipment Setup

Electrical Connections

The HM-5760 is equipped with an internal digital switching power supply, which allows it to be used with most power configurations throughout the world. The unit is supplied with an IEC electrical cord with a standard 110V plug.

The HM-5760 arrives ready for operation. Attach the supplied IEC electrical cord to the machine and plug into a standard wall receptacle for use in the United States. For locations other than the U.S., replace the supplied electrical cord with an IEC cord that has the correct plug for your application. The supplied cord can also be used by cutting the standard plug from the cord and attaching the correct plug.

Power Switch

The Power Switch is located on the upper right hand corner of the back of the machine, above the electrical cord inlet. The Fuse Compartment is located between the electrical cord inlet and the Power Switch. The HM-5760 uses a 10 amp fuse. To begin operation, attach the supplied electrical cord, plug it in and press the Power Switch.



Fuse Compartment

Fig. 1 Power Switch

Air Connection

A constant supply of clean, dry air is required for operation. The air connection is located in the rear of the base cabinet, see photo below. The air connection is 1/4" (6mm) OD. Insert tubing (supplied) into the quick-connect until it bottoms out, and make sure the connections are tight.



Air Connection

The inlet air pressure should not exceed 150psi (1000 kpa). Minimum air pressure should be set at least 20psi higher than expected operating pressure. For a maximum vertical operating load of 10kN (2000 lb), the pressure required would be 95psi.

See pages 23-24 for more information about air supply accessories for your HM-5760.

Instrumentation Connections and Setup

HM-5760 Rear Instrumentation Panel



Above is a photo of the rear instrumentation panel of the HM-5760.

Network (1)

Ethernet input for connecting machine to a local area network (LAN) and/or the internet.

USB Power (2)

The USB Power port is used for powering a wireless access appliance for those who want to use a wireless LAN setup.

Instrument Inputs (3)

The panel features four (4) inputs for connecting instrumentation to the machine. Each input represents a separate channel, and has been assigned and calibrated to a specific instrument for use with your HM-5760.

Below are photos of an instrumentation input and the instrumentation plug. Install the plugs into the inputs by lining up the guide at the bottom of the plug with the slot at the bottom of the input.



Instrumentation Input

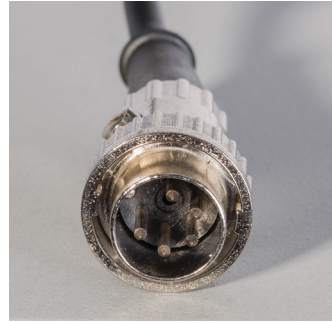

Instrumentation Plug

Once you have installed the instrumentation into the correct inputs, your rear panel should look like this:



Initial Set Up

Remember, your HM-5760 Direct/Residual Shear Machine includes all the necessary instrumentation, which is already calibrated and assigned to an Input and will not need calibration, however you should confirm that the instrumentation has been set up and calibrated, that you have plugged them into the correct channel, and that you check with your QC/QA program to set up a frequency of calibration schedule.

DO NOT RECALIBRATE!

When your HM-5760 is first turned on, the screen below will appear.

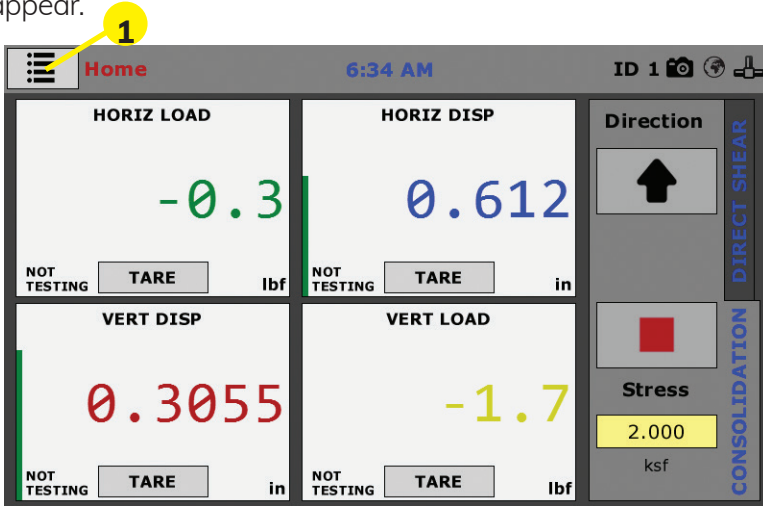

From this screen, to confirm your machine instrumentation has been calibrated, navigate to the Calibration section by clicking the Menu icon in the top left corner of the screen (1). When you click on this button, you will see a drop-down menu appear, see below.

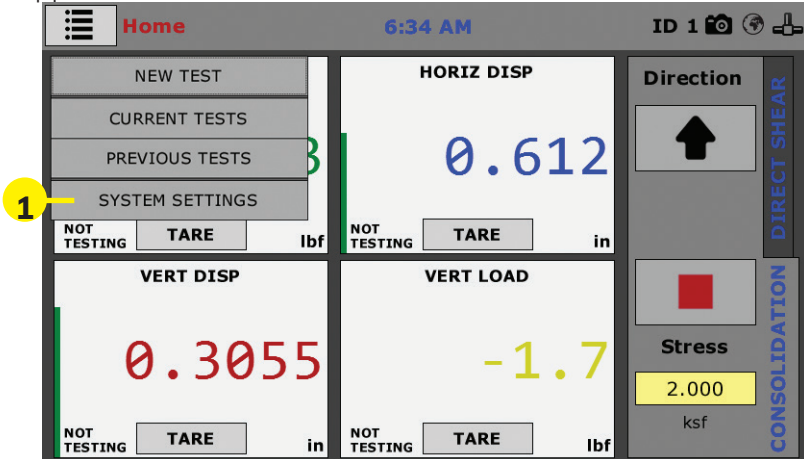

Navigate to the bottom of this drop-down menu and click on System Settings (1). You will see the following screen.

Initial Set Up — Calibration

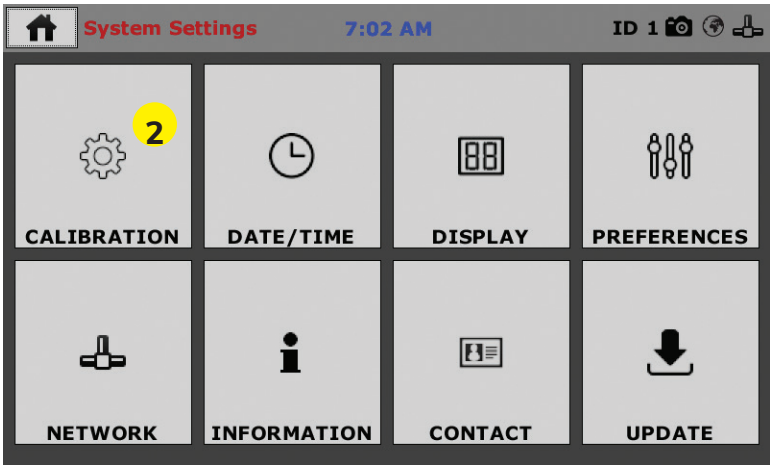

Click on the Calibration tab in the top left corner (2). You will see the following screen.

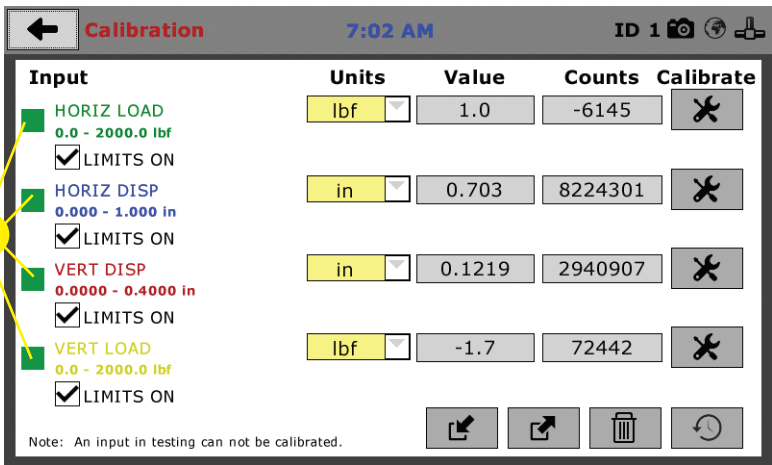

Calibration Input Screen

The Calibration Input Screen (above) is used to monitor and calibrate instrumentation and assign them to specific channels of the HM-5760. The Calibration Input Screen provides a summary of the calibration status of each channel. At this time, verify the calibration information.

A green box at the left of a channel indicates that the channel has instrumentation assigned to it and that it is calibrated and ready for use (1).

Calibration Input Screen, cont.

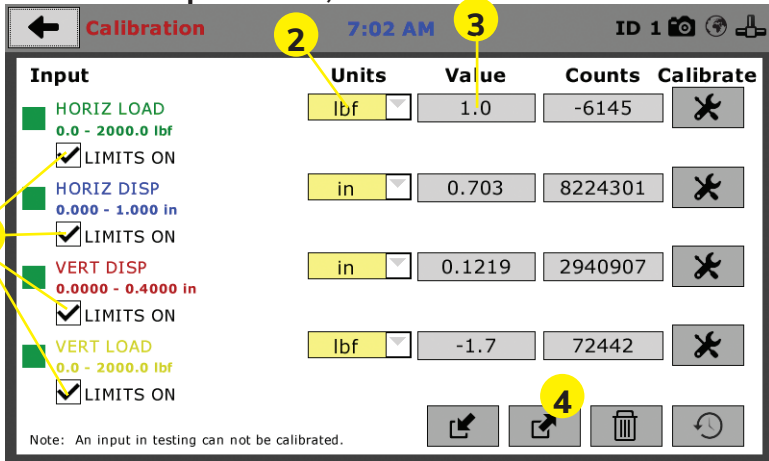

Each channel has a “Limits On” check box (1). Use the Limits On to keep the machine from exceeding the sensor limits of the instrumentation. By selecting this option, before the test can exceed the limits of the sensors, all tests will stop running and the motor will stop to avoid damaging connected instrumentation.

Note: An input cannot be calibrated during testing.

Units (2)

In this field, a calibrated instrument will display the units that were chosen for use at the time of calibration. This field can also be used to automatically toggle conversion of units between lb.-in. and SI units if the need arises.

Value (3)

This field displays the current calibration value. This value should already be set with 3 decimal point accuracy (1) below. If the instrument is not calibrated, the unit will read “N/A.”

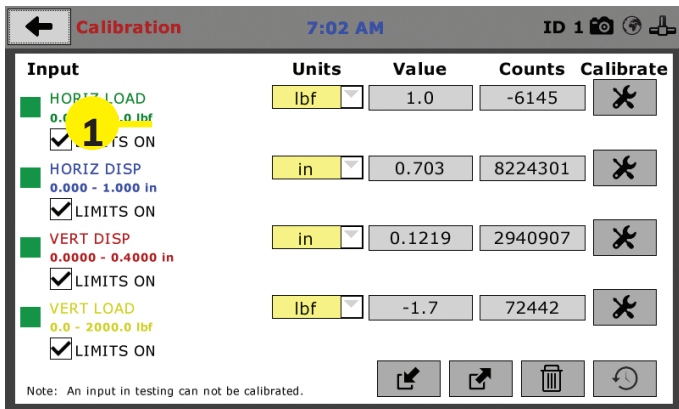

For the HM-5760, values for vertical and horizontal loads will be set at 10.000kN (2000.0 lb), for vertical displacement this value will be set at 10.000mm (0.4000”) and for horizontal displacement this value will be set at 25.000mm (1.000”)

Export Calibration via USB (4)

Press this button to select calibrations to export via USB. It is a good practice to export all your calibrations to a thumb drive. In case of a problem this practice allows you to recover your calibration data quickly.

Initial Set Up — Date and Time

To set up Date and Time settings, return to the System Settings screen and click on the Date/Time Panel. **(1)**

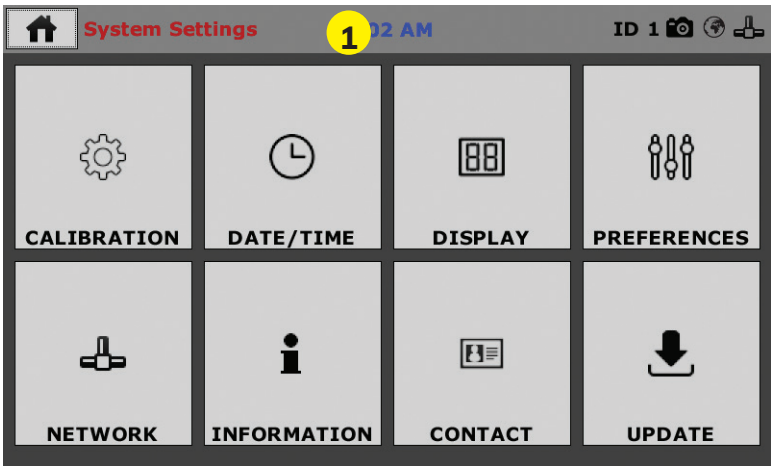

Click on the Date/Time tab **(1)**. You will see the following screen.

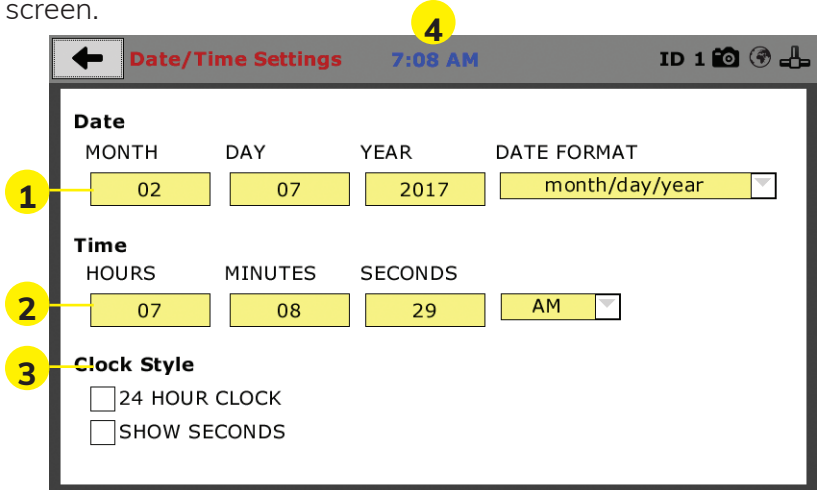

Date (1)

Set the month, day, year, and date display format.

Time (2)

Set the hours, minutes, seconds, and am/pm.

Clock Style (3)

Select a clock view, either a 24-hour or 12-hour clock, as well as the option to show seconds or not.

Clock (4)

The current time is displayed and is located on every controller screen. Clicking on the time from any screen, you will be taken to the Date/Time Settings Screen.

Initial Set Up — Display

To set up Display settings, return to the System Settings screen and click on the Display Panel. **(1)**

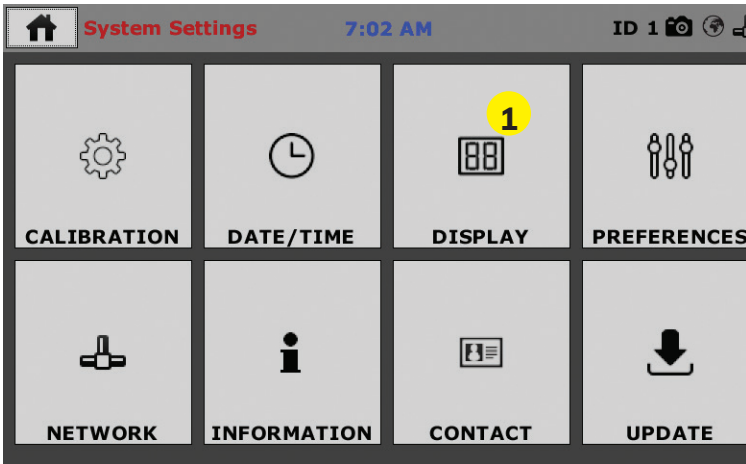

Click on the Display tab **(1)**. You will see the following screen.

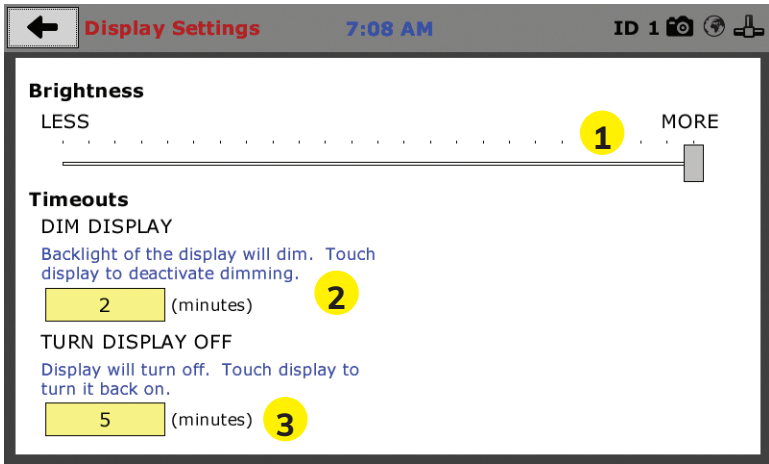

Brightness (1)

Slide the gray bar to the left or right to adjust brightness.

Dim Display (2)

The backlight of the display will automatically dim to save power. Click the yellow box to change the number of minutes before the display goes dim. After the time has elapsed, touch the display to deactivate dimming.

Turn Display Off (3)

The display will automatically turn off to save power. Click the yellow box to change the number of minutes before the display powers off.

Initial Set Up — Preferences

This screen is accessed by clicking on the “Preferences” button. (1)

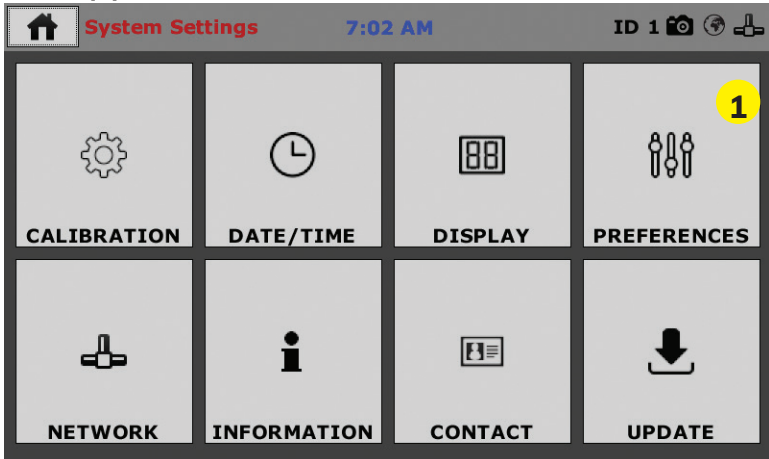

Click on the Preferences tab (1). You will see the following screen.

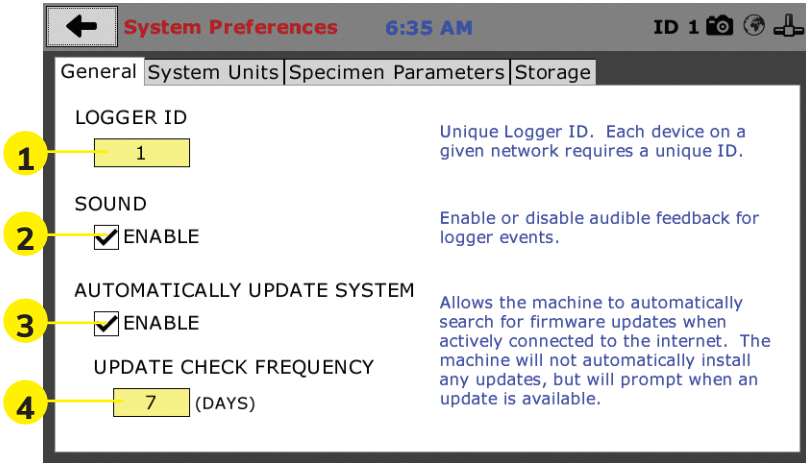

Preferences – General Tab

The Preferences panel is comprised of four (4) tabs and defaults to the General tab, see above.

Logger ID (1)

Each machine that is connected to your network requires a unique Logger ID. These numbers can be assigned any number between 1-245. In most cases, if you are setting up a new machine it has been given the Logger ID 1. This would show in the Logger ID field. (1). If this number conflicts with another machine’s Logger ID, one of the machines will have to be changed to another Logger ID.

Sound (2)

Checking this box enables or disables audio feedback for logger events.

Automatically Update System (3)

Checking this box allows the machine to automatically search for firmware updates when actively connected to the Internet. The machine will not automatically install updates; it will prompt when an update is available.

Update Check Frequency (4)

The number placed in this box represents the frequency (how many days) the machine checks for updates.

Preferences – System Units Tab

This screen is accessed by clicking on the “System Units” Tab under System Preferences.

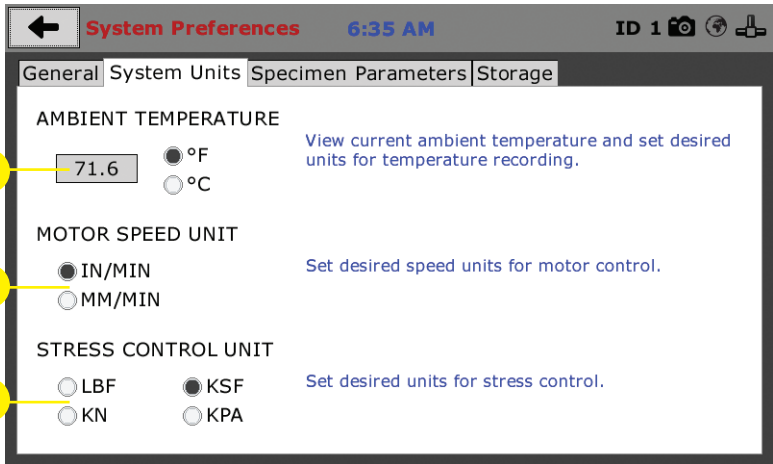

Ambient Temperature (1)

This field displays the current ambient temperature and allows you to select desired units (Fahrenheit or Celsius) for temperature recording.

Motor Speed Unit (2)

Click on the desired units you want to use for motor control (in/min or mm/min).

Stress Control Unit (3)

Click on the desired units you want to use for stress control (LBF, KN, KSF OR KPA).

Preferences – Specimen Parameters Tab

This screen is accessed by clicking on the Specimen Parameters Tab under System Preferences.

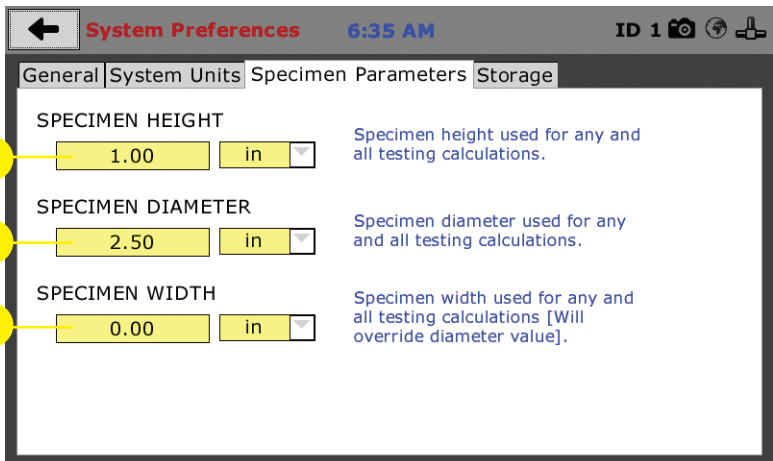

Specimen Height (1)

This field allows you to set the specimen height that will be used for all testing calculations.

Specimen Diameter (2)

This field allows you to set the specimen diameter that will be used for all testing calculations.

Specimen Width (3)

This field allows you to set the specimen width that will be used for all testing calculations.

Preferences – Storage Tab

This screen is accessed by clicking on the Storage Tab under System Preferences.

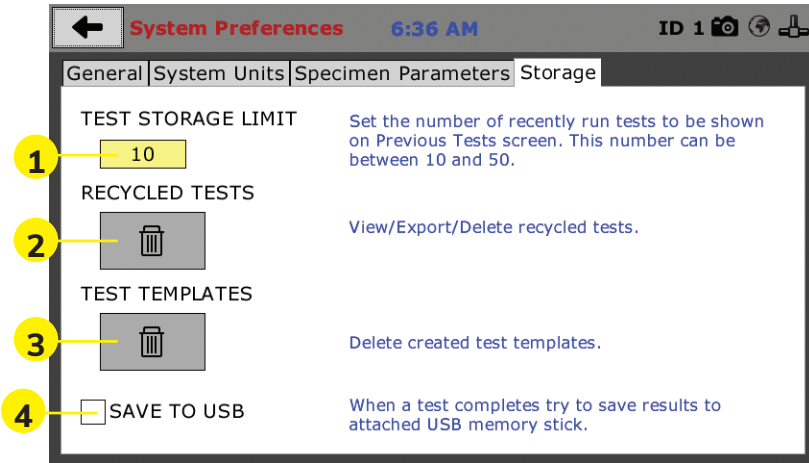

Test Storage Limit (1)

This field allows you to set the number of previously run tests to be available on the “Previous Tests” screen. This number can be between 10-50.

Recycled Tests (2)

This refers to previously run tests that are not displayed in the “Previous Tests” window. These tests are not deleted; they are recycled for later use. Select this button to view/export/delete recycled tests.

Test Templates (3)

Select this button to delete test templates that have been created, but are no longer desired.

Save to USB Check Box (4)

Checking this Box saves the results of a test to USB thumb drive inserted into the front USB slot on the machine.

Initial Set Up — Network

To set up Network settings, return to the System Settings screen and click on the Network panel. **(1)**

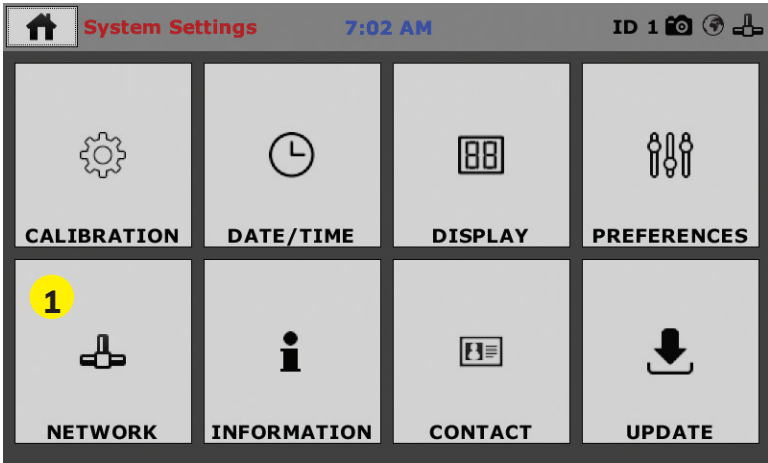

A password is required to access the Network Settings. That password is: **27604**.

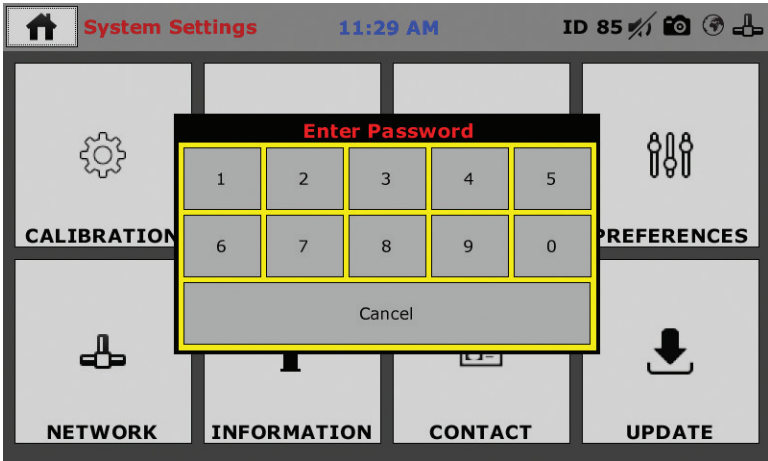

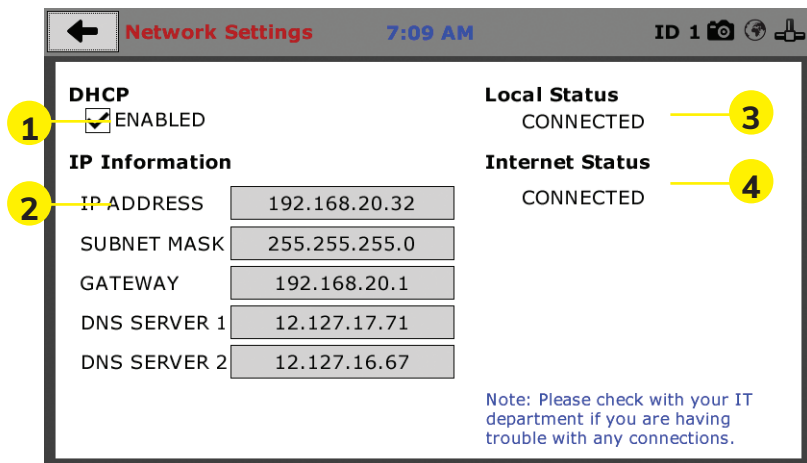

Network Settings Screen

The screen above is the Network Settings screen, it provides information on your IP information and network status.

DHCP (1)

Check this box to enable/disable the Dynamic Host Configuration Protocol (DHCP). If enabled, your machine will pick up IP information from your router. If disabled, you will need to manually enter the network information for a static IP, please consult your network administrator for this.

IP Information (2)

This information will be filled in automatically if the DHCP is checked, otherwise you will have to manually supply this information. The IP address must be unique for each machine.

Local Status (3)

This indicates the status of the local network connection, Connected or Disconnected.

Internet Status (4)

This indicates the status of your Internet connection, Connected or Disconnected.

Note: If you are experiencing issues with any connections, please contact your IT department for assistance.

Initial Set Up — Information

Clicking on this panel provides a view of the current status of the machine. (1)

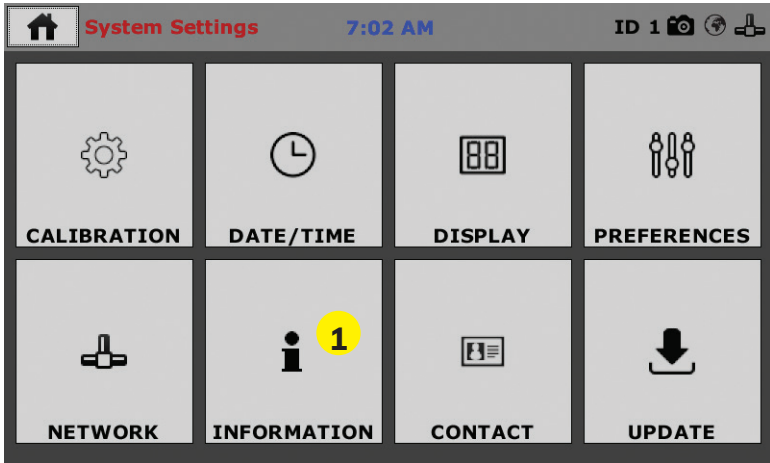

System Information

Below is a view of the System Information screen. It provides a current status of the machine.

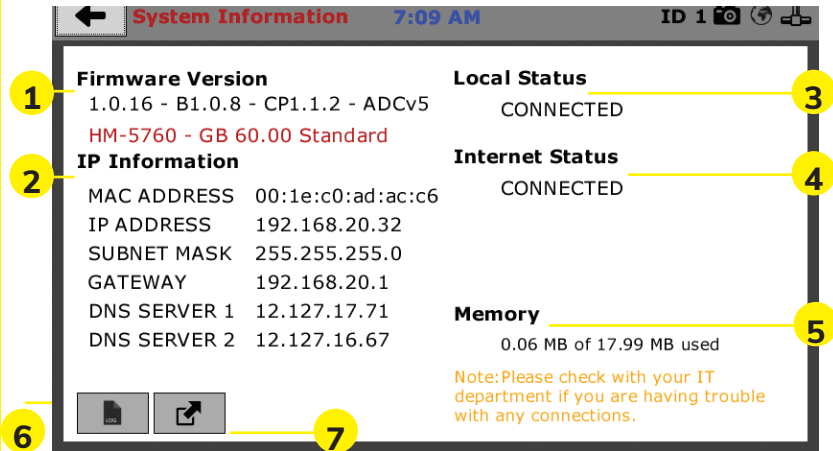

Firmware Version (1)

The current version of the machine firmware is shown here. If you contact product support, you will need to supply this information.

IP Information (2)

This information will be filled in automatically if DHCP is checked, otherwise you will have to manually supply this information. The IP address must be unique for each machine.

Local Status (3)

This indicates the status of the local network connection, Connected or Disconnected.

Internet Status (4)

This indicates the status of your Internet connection, Connected or Disconnected.

Memory (5)

This indicates the current status of how much available memory is being used by the machine

Factory Screen (6)

This is for Humboldt use only.

Export Log File (7)

This button exports a log file from the machine to a USB thumb drive. Be sure to insert a thumb drive before exporting the file or you will receive an error. This file can be helpful in trouble shooting by Humboldt Support.

Initial Set Up —Contact

Clicking on this panel provides contact information for Humboldt Support and Service(1)

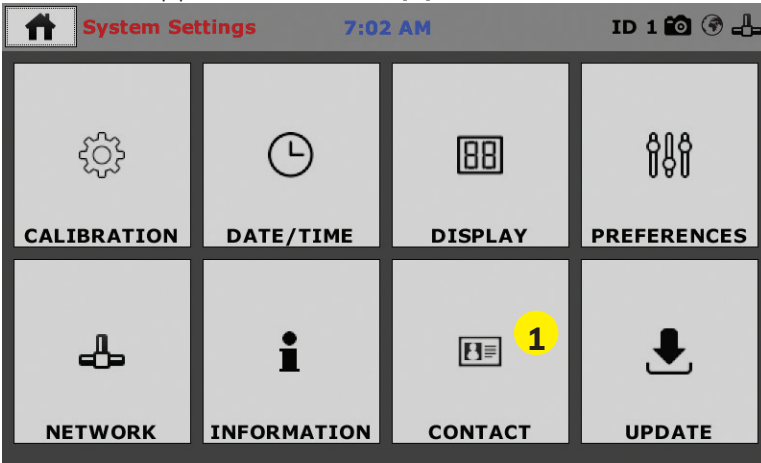

Contact Information

Below is a view of the Contact Information screen showing contact information for Humboldt Support and Service.

For quickest response go to this link on our website: <https://www.humboldtmg.com/support> and fill in the support form. This will provide us with the necessary information to assist you and you will be added to the next position in the support cue.

You can also email Humboldt Support at support@humboldtmg.com or Humboldt Service at service@humboldtmg.com. Please include contact information and a detailed description of your reason for contact.

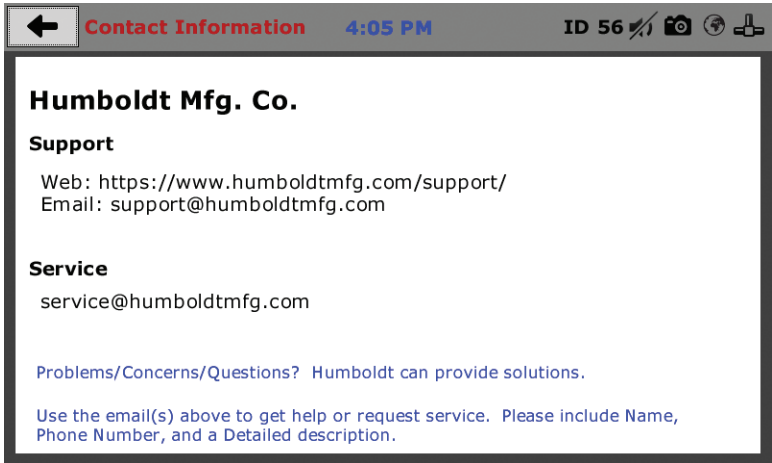

Initial Set Up — Update

Clicking on this panel provides information on checking for Updates, performing updates and an update history for the machine. **(1)**

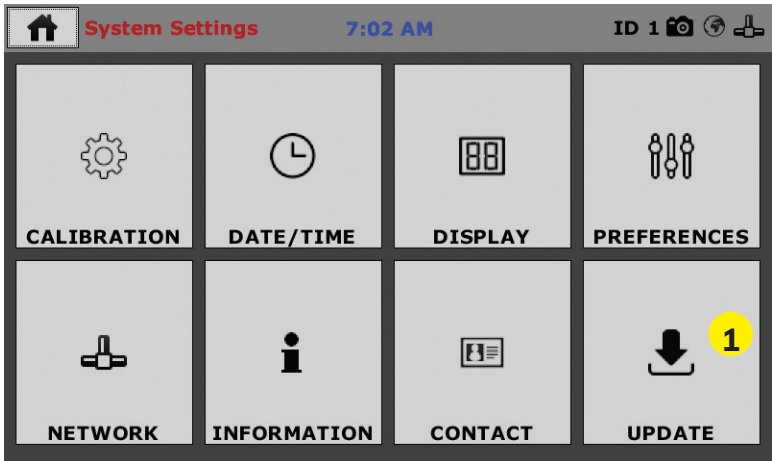

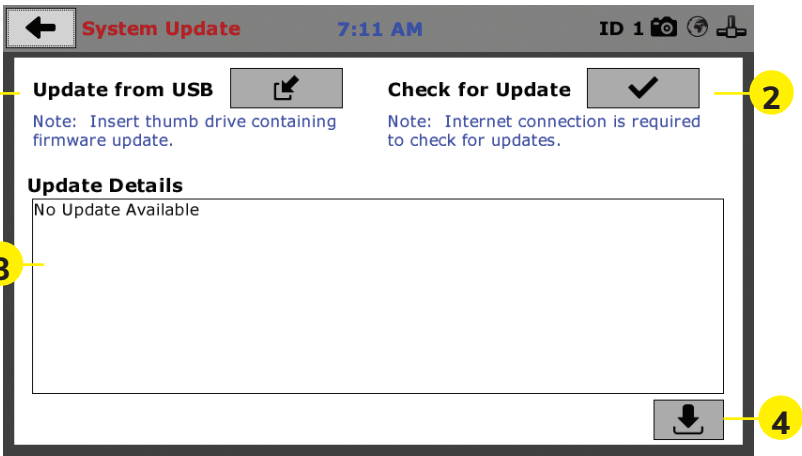

Update from USB (1)

If your HM-5760 is not connected to the internet, Software updates for your machine can be downloaded from the Humboldt website Support Area using a computer. To access the Software Update area, go to: <https://www.humboldtmg.com/support/software.php>.

Once on this page, click on the Elite Series Firmware tab. You will see a list of Humboldt Elite Series machines. Click on the HM-5760 Current Version link and the firmware update will begin to download to your computer. Once the download is complete. Load the file onto a USB thumb drive and insert the thumb drive into the USB port on the front of the HM-5760. With the USB thumb drive inserted into the USB port, click on Update from USB **(1)**.

A window will open and you will see a list of Updates. Select a file to use for your update and click the Select button.

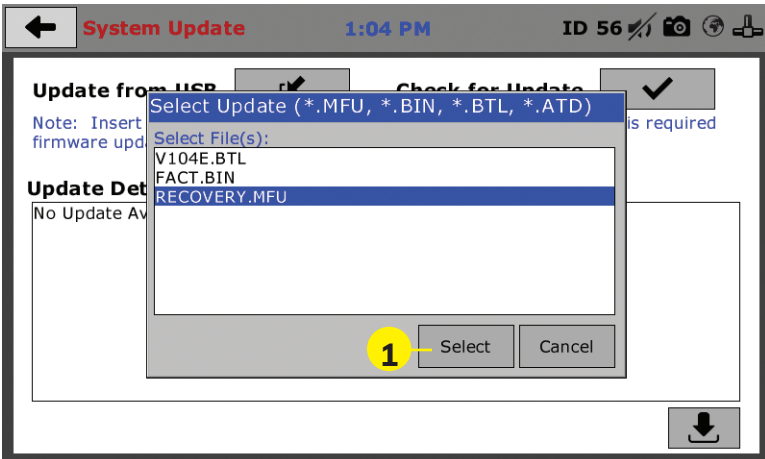

The update process will begin. This may take several minutes. Your HM-5760 may reboot several times during the update, do not turn off or reset machine during this process.

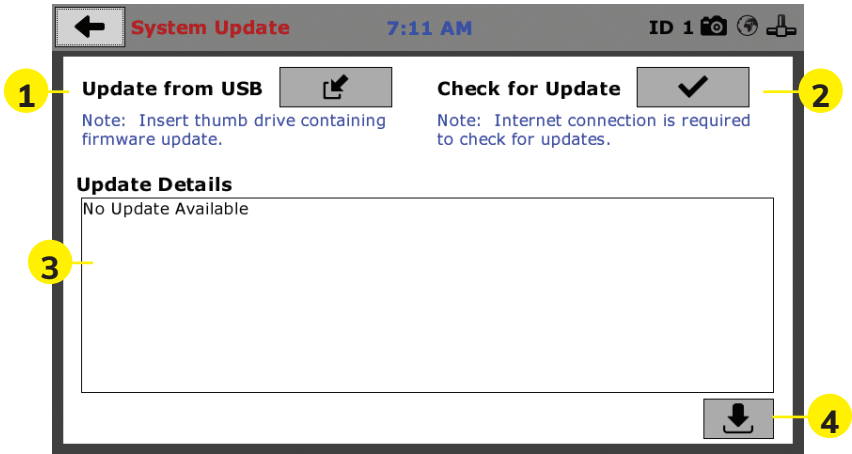

Check for Update (2)

If your HM-5760 is connected to the internet, you can have the machine check automatically for updates, which can be found under System Settings – Preferences button. How often the machine checks for updates can be customized under Preferences. However, you may click on the Check for Update button (2) to force an immediate check for updates.

Update Details (3)

If you have chosen to have the HM-5760 check for updates automatically, this box will display a running list of updates currently available for your machine, but, which have not been installed.

Download Updates (4)

Clicking this button will download updates for your machine and automatically install them. To accomplish this, the machine must be connected to the internet. Machine will install, turn-off and restart. Wait until installation is complete and the window indicates: Ready for Testing.

You can tell that there is an update available by the appearance of the following icon in the window header (1), see next page.

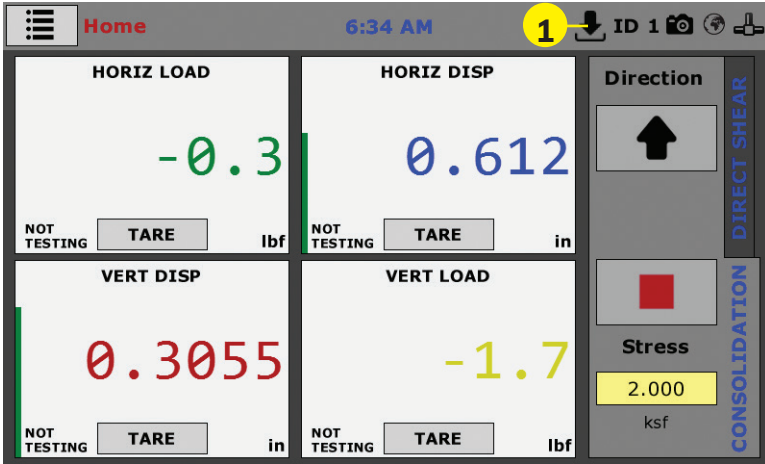

Operation from a Computer and NEXT Software

This manual covers the setup and operation of the HM-5760.3F Pneumatic Direct/Residual Shear Apparatus in Stand-alone Mode only. For information on operating your load frame with Humboldt's NEXT Software and a computer, please refer to the Humboldt NEXT software manual.

Equipment Setup



Installation and Equipment Setup

Electrical Connections

The HM-5760 is equipped with an internal digital switching power supply, which allows it to be used with most power configurations throughout the world. The unit is supplied with an IEC electrical cord with a standard 110V plug.

The HM-5760 arrives ready for operation. Attach the supplied IEC electrical cord to the machine and plug into a standard wall receptacle for use in the United States. For locations other than the U.S., replace the supplied electrical cord with an IEC cord that has the correct plug for your application. The supplied cord can also be used by cutting the standard plug from the cord and attaching the correct plug.

Power Switch

The Power Switch is located on the upper right hand corner of the back of the machine, above the electrical cord inlet. The Fuse Compartment is located between the electrical cord inlet and the Power Switch. The HM-5760 uses a 10 amp fuse. To begin operation, attach the supplied electrical cord, plug it in and press the Power Switch.

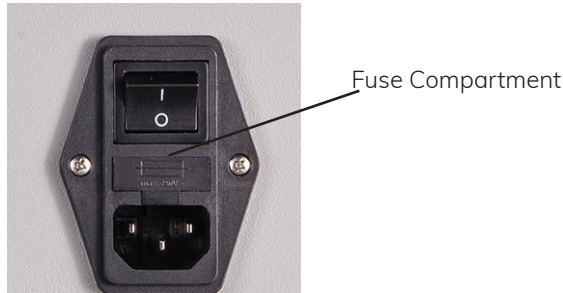

Power Switch

Air Connections

A constant supply of clean, dry air is required for operation. The air connection is located in the rear of the base cabinet, see photo below. The air connection is 1/4" (6mm) OD. Insert tubing (supplied) into the quick-connect until it bottoms out, and make sure the connections are tight.

The inlet air pressure should not exceed 150psi (1000 kpa). Minimum air pressure should be set at least 20psi higher than expected operating pressure.

The inlet air pressure should not exceed 150psi (1000 kpa). Minimum air pressure should be set at least 20psi higher than expected operating pressure. For a maximum vertical operating load of 10kN (2000 lb), the pressure required would be 95psi.



Air Connection

It is highly recommended that you use some type of refrigerant or desiccant dryer and regulator in your machine setup. Humboldt offers the following items for this purpose.

Refrigeration Dryer, 115V 60Hz 1ph

HM-4221

Compressed air quality is often overlooked in many labs. Compressed air contains condensate which, when cooled, will turn into water, causing extensive damage to both the compressed air network and testing equipment. Refrigeration dryers actively remove this condensate to achieve near perfectly dry compressed air. The benefits are notable: less system downtime, reduced costs and maintenance, and improved test equipment life. This refrigeration dryer, thanks to its PlusPack heat exchanger and the most compact dimensions on the market, will prove a major asset in your lab. Dryer uses a 1/2" NPT-F pipe size and nominal flow is: 10 SCFM, 17 Nm³/hr and 0.3 Nm³/min. based on an ambient and inlet temperature of 100°F (38°C) and a working pressure of 100 psig (7 bar)



HM-4221

Desiccant Dryer

HM-4222

Ideal for drying small volumes of air at the point of use. Convenient in-line mounting saves space. ISO Class 2 dryer. Max. operating pressure is 150 psig. and max operating temperature is 125°F. Total capacity is 4400 ft³, Female NPT inlet/outlet size is 0.25 NPTF, bowl size is 1.75 lbs, Height 11 Inches, Width 4.625", Includes one charge of desiccant



HM-4222



HM-4223

Filter/Regulator

HM-4223

One-piece, Filter/Regulator, 0-125 psi (0 - 8.6 bar) with standard filtration of 5 micron. Height is 9.77 and width is 2.36. Bowl material is polycarbonate and includes sight glass and pressure gauge.

Also, you will need a source of compressed air. Humboldt offers the following air compressors.

Compressor, 120V 50/60Hz

HM-4220

Compressor, 220V 50/60Hz

HM-4220.4F

When operating under full load this exceptionally quiet compressor offers a tremendously low noise level of 40 db/A. Each compressor is built with quality in mind, and comes equipped with powder-coated air tank, pressure switch, 1-micron air filter, regulator, and pressure gauges for completely automatic and trouble free operation.



HM-4220

High-Vacuum Pump, 120V 60Hz

H-1763A

High-Vacuum Pump 230V 50/60Hz

H-1763A.4F

Direct-drive two-stage rotary sliding vane high vacuum pump features gas ballast and trap to reduce risk of oil being sucked into the system. Produces free air displacement 85L per minute (3 cu. ft. per minute) and maximum vacuum 29-30". Operating temperature is 30 to 170°F (-1.11 to 76.6°C). Has 0.25" OD intake ports for 0.25" ID tubing. Dimensions: 11.25" x 15.5" x 6.5" (28.6 x 39.4 x 16.5cm).



H-1763A

Shear & Consolidation Installation Kit

HM-4168

Kit designed to provide fittings, connectors, tubing and tools to complete a triaxial set up installation. Kit includes items in the table below. All items can be purchased individually as well.



HM-4168

Shear & Consolidation Kit Components	
.25" OD Tubing, 100ft.	HM-4196.25
.375" to .25" Reducer Bushing (3)	HM-4150.77
Cutter, Flexible Tubing (1)	HM-000058
Thread Tape, PTFE (1)	HM-000059
Wrench, Adjustable, 6" (1)	HM-000064
Union T Fitting, .25" (5)	HM-4150.45
Quick Valve Coupling, .25" (2)	HM-4150.72
Regulator Elbow, .25" (3)	HM-4150.44
Tube Fitting T, 6mm OD (5)	HM-003175
Push-to-Connect Tube Fitting Coupler, .25" OD (4)	HM-003176

Determining compressor size requirements, based on your lab needs can be discussed with your Humboldt representative.

Instrumentation Connections and Setup

HM-5760 Rear Instrumentation Panel



Above is a photo of the rear instrumentation panel of the HM-5760.

Network (1)

Ethernet input for connecting machine to a local area network and/or the internet.

USB Power (2)

The USB Power port is used for powering a wireless access appliance for those who want to use a wireless LAN setup.

Instrument Inputs (3)

The panel features four (4) input channels for connecting instrumentation to the machine. Each input represents a separate channel, and has been assigned and calibrated to a specific instrument for use with your HM-5760.

Below are photos of an instrumentation input and the instrumentation plug. The instrumentation plugs have been numbered and should be installed in the corresponding numbered input. Install the plugs into the inputs by lining up the guide at the bottom of the plug with the slot at the bottom of the input channel. Ignore the locking collar on the plugs they are not required for this application.

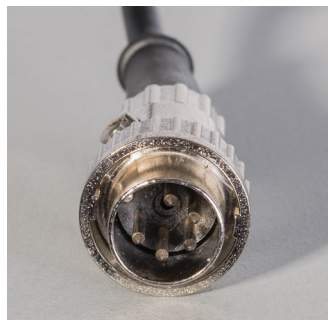

Once you have installed the instrumentation into the correct inputs, your rear panel should look like this:



Test Deck Setup

Below is a how your HM-5760 should be set up for operation. When you receive your unit, your instrumentation should already be mounted in place. It has been tied down with plastic ties for shipping so you should remove these ties before operation. You may have to make small position adjustments to the instrumentation for optimal operation.

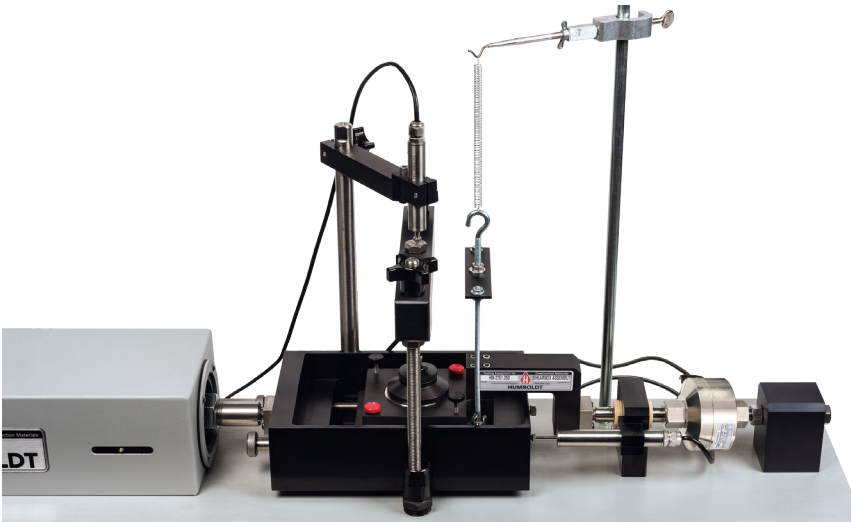

Shearbox Assembly

Shearbox assemblies are not included with the HM-5760 Direct Shear Machine, but are required. They are available in both round and square configurations in several sizes, see below. You, most likely, ordered at least one for use with your HM-5760.



HM-2751.25D



HM-2751.60S

Shearbox Assemblies	
Round	Model
2.0"	HM-2751.20D
2.42"	HM-2751.24D
2.5"	HM-2751.25D
4.0"	HM-2751.40D
50mm	HM-2751.50D
60mm	HM-2751.60D
100mm	HM-2751.100D

Shearbox Assemblies	
Square	Model
2.0"	HM-2751.20S
2.42"	HM-2751.24S
2.5"	HM-2751.25S
4.0"	HM-2751.40S
50mm	HM-2751.50S
60mm	HM-2751.60S
100mm	HM-2751.100S

Shearbox assemblies include: sample shearbox, (2) porous plates, (1) loading pad, and (1) grid plate. All shearboxes feature mounting screws for use with the ASTM D3080-compliant counter-balance device.

Shearbox Replacement Screws

Replacement screws for shearboxes are available:

Thumbscrew, Metal, Black Head HM-003274

Thumbscrew, Plastic HM-003275

Thumbscrew Head, Red HM-003276

Sample Prep

Please refer to ASTM D3080 for instructions on sample preparation. Humboldt offers the following items to aid in sample preparation.

Accessory	Model
Cutter	HM-2702.XXS/D
Dolly tamper	HM-2703.XXS/D
Porous plate	HM-2704.XXS/D
Calibration disk, square	HM-2755.XXS
Calibration disk, round*	HM-1220.XX.4
Replacement Pressure Ball 5/8" 440 Stainless Steel	HM-001076

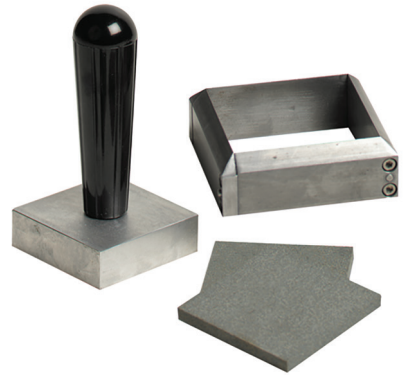

* Can be used for shear boxes and consolidation cells.

Part Numbers ending in .XX require a size code to be entered referring to the sample size to be tested.

For direct/residual shear samples, sizes are: .20 = 2.0"; .242 = 2.42"; .25 = 2.5"; .40 = 4.0"; .50 = 50mm; .60 = 60mm, and .100 = 100mm. **NOTE:** use "S" for square and "D" for round samples.

Shearbox Placement

Once you have prepared your sample and are ready to place the shearbox into the HM-5760, place the shearbox into the reservoir/carriage and slide it as far to the right as it can go. Refer to the photo on page 26 for placement. Once the shearbox is placed into the reservoir/carriage, tighten the two large screws located on the left of the reservoir/carriage to secure the shearbox in place. Make sure that the horizontal load cell butts up to the shearbox and tighten all adjustment screws.

Once the shearbox is in place, attach the counter-balance device for ASTM D3080 compliance to the long steel screws on the right side of the shearbox. Remove the plastic screws with the red heads from the shearbox and using the metal screws separate the shear box halves to approximately the diameter of the maximum-sized particle in the test specimen or 0.025". (0.64 mm). Once this is completed, adjust the counter-balance device as necessary to apply a counter force for the purpose of counteracting the weight of the top half of the shear box. To adjust:

1. Coarse adjustment is accomplished by raising or lowering the support hook assembly. To do so, loosen the thumbscrew on the support hook and adjust the position of the hook. Tighten the thumbscrew again to secure the support hook.

2. Fine adjustment is accomplished by loosening the nuts that secure either the hooks on the hanger bar and adjusting the hooks up or down. When the adjustment is complete, tighten the nuts to secure the hooks.

Once this is completed unhook the spring from the hook supporting the hanger bar and load your test specimen into the shearbox. When this is complete, reattach the spring to the hook supporting the hanger bar. At this point you would be ready to test.

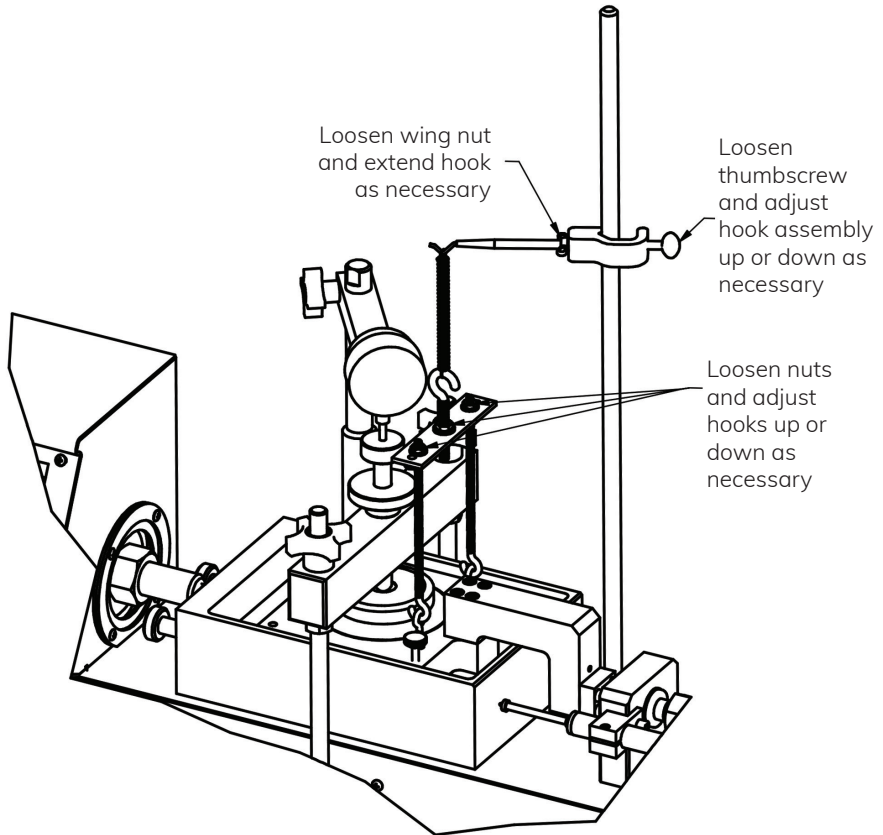

Humboldt recommends using this guide to familiarize yourself with the operation of your HM-5760 Direct Shear machine's operation, before doing actual testing. We also suggest you use some insignificant samples or samples made specifically for setup purposes before testing real samples.

Calibration of Instrumentation

The HM-5760 Direct/Residual Shear Machine includes all necessary instrumentation. All instrumentation included with this unit has been calibrated and assigned to specific channels for use. These channels are marked on the corresponding instrumentation and the correct calibration information will appear in the channel calibration parameters, once you have installed the instrumentation to the correct inputs.

DO NOT RECALIBRATE!

How to Perform a Calibration

All instrumentation included with this unit has been calibrated and assigned to specific channels for use. Humboldt recommends and standard lab practice dictates that your HM-5760 should be calibrated periodically. For most, this period is usually a year, though other rules may apply to the frequency of calibration.

To perform a calibration, it will be necessary to either hire a calibration service to come in to calibrate your machine or have the necessary calibration equipment to perform this service.

To begin a calibration, it is always a good idea to save the current calibration settings. If you have already saved these settings to a USB thumb drive or your computer, this step can be skipped.

Export Calibration via USB (4)

Press this button to select calibrations to export via USB. It is a good practice to export all your calibrations to a thumb drive. In case of a problem this practice allows you to recover your calibration data quickly.

The screenshot shows the 'Calibration' screen with a top bar containing a back arrow, the title 'Calibration', the time '7:02 AM', and icons for ID 1, camera, globe, and a download icon. The main area is a table with columns: Input, Units, Value, Counts, and Calibrate. There are four rows of calibration data, each with a green square icon on the left and a 'Calibrate' button with a wrench icon on the right. At the bottom, there are four icons: a left-pointing arrow, a right-pointing arrow, a trash can, and a refresh icon. The trash can icon is circled in yellow with the number '5', and the right-pointing arrow icon is circled in yellow with the number '4'. A note at the bottom left states: 'Note: An input in testing can not be calibrated.'

Input	Units	Value	Counts	Calibrate
HORIZ LOAD 0.0 - 2000.0 lbf <input checked="" type="checkbox"/> LIMITS ON	lbf	1.0	-6145	
HORIZ DISP 0.000 - 1.000 in <input checked="" type="checkbox"/> LIMITS ON	in	0.703	8224301	
VERT DISP 0.0000 - 0.4000 in <input checked="" type="checkbox"/> LIMITS ON	in	0.1219	2940907	
VERT LOAD 0.0 - 2000.0 lbf <input checked="" type="checkbox"/> LIMITS ON	lbf	-1.7	72442	

Note: An input in testing can not be calibrated.

Once your calibrations have been saved, click on the trash can icon (5) to begin to erase all four (4) Input calibrations. When you press the trash can icon, this screen will appear.

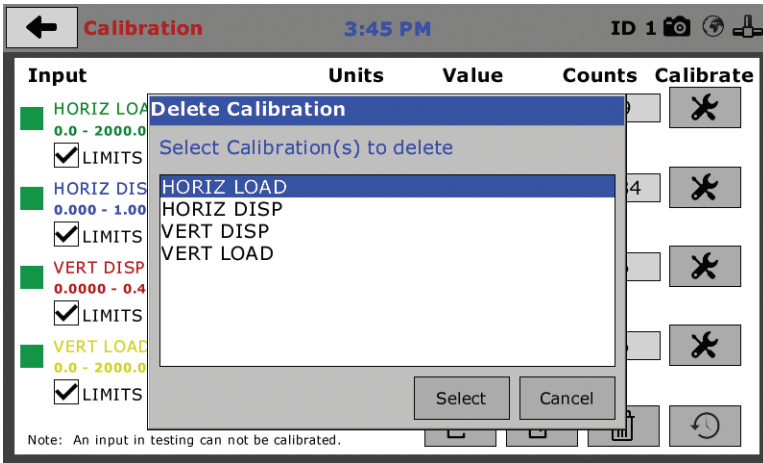

On this screen select an Input calibration to delete, one at a time, and then press the Select button. The channel will be deleted. Do this for all four (4) channels.

Once all Input calibrations have been cleared, your Calibration window should look like the one below with no Inputs calibrated.

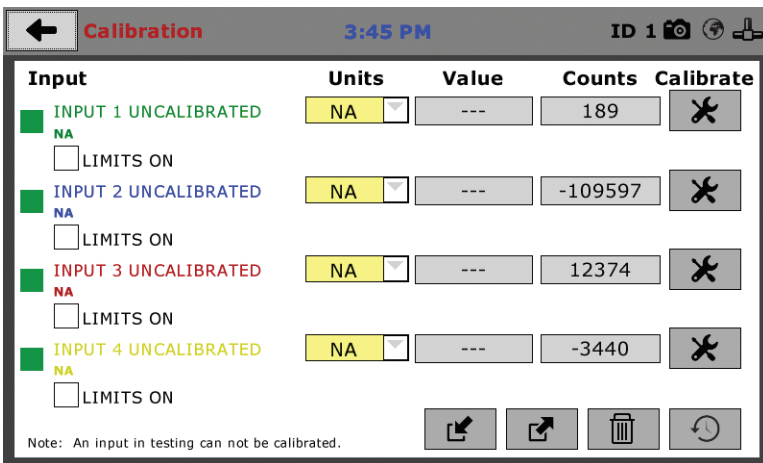

The four Inputs of the HM-5760 have been programmed so that Input One (1) is always set to be Horizontal Load. Input Two (2) is programmed to be Horizontal Displacement. Input Three (3) is programmed to be Vertical Displacement and Input Four (4) is programmed to be Vertical Load.

Calibrating your instrumentation to the appropriate Input requires a separate device, which can provide precise and specific loads or displacement, and, which has been certified to be accurate. The calibration process involves plugging the instrumentation into the HM-5760 while

placing the instrumentation into the certified calibration device, which provides a specific set load or displacement.

Once this has been done, click the Calibrate button next to the appropriate Input **(1)**.

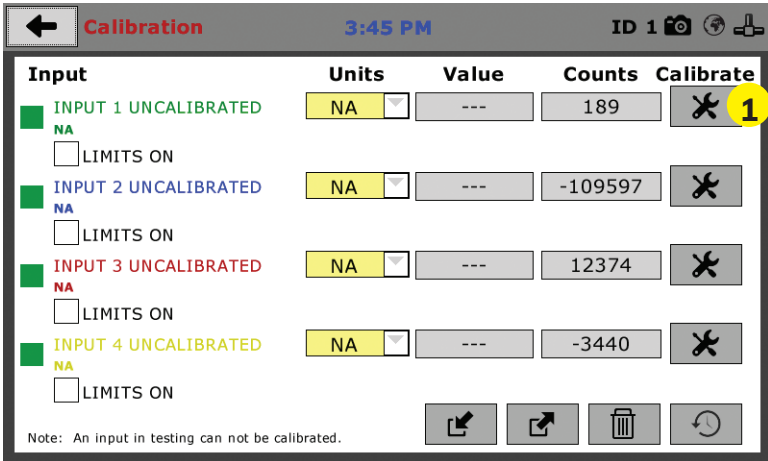

A pop-up window will appear requiring you to enter the password, which is **22234**.

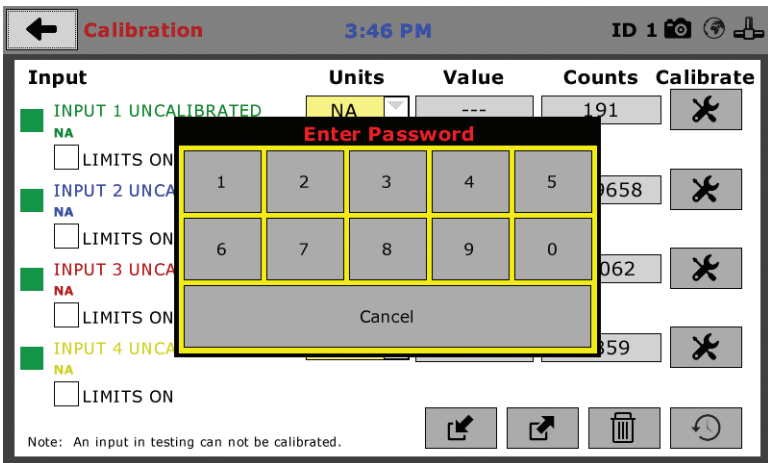

Upon filling in the password, you will see this screen, Tab 1 Sensor Details of the Calibration settings.

The screenshot shows the 'Input 1 Calibration' interface. At the top, there is a navigation bar with a back arrow, the title 'Input 1 Calibration', the time '9:59 AM', and icons for ID 1, camera, and other functions. Below the navigation bar are four tabs: '1. SENSOR DETAILS', '2. LIMITS', '3. MULTI POINT', and '4. NAME'. The '1. SENSOR DETAILS' tab is active. The main content area is titled 'Select Connected Sensor:' and includes the instruction 'Please choose the instrumentation type that is connected.' There are three numbered steps: (1) TYPE is set to 'HORIZONTAL LOAD'; (2) CAPACITY is set to '0' with a unit dropdown set to 'kN'; (3) FS OUTPUT is set to '0' with a unit dropdown set to 'mV/V'. A right-pointing arrow button is located at the bottom right of the form.

On Tab 1, the Sensor Type **(1)** will default to Horizontal Load. For Capacity **(2)**, fill in the maximum capacity of the sensor and choose either lbf or kN. For FS output **(3)**, refer to the calibration sheet, which came with the instrument your are using and enter it here and then choose mV/V. Below are typical calibration sheets with the FS Output information highlighted in orange.



Humboldt Calibration Certificate

Model	HM-2300 020
Full Scale Output	3.000 mV/V
NTEP#	06-080
Serial#	216907
Capacity	2,000 lb
Date	01/20/2017

Zero Balance	1.00% FS
Rated Excitation	10 Vdc
Compensated Temp. Range	14 to 104 °F (-10°C to 40°C)
Insulation Res.	>1,000 Megohms at 50V DC
Barometric Effect	Nil
Input Resistance	385± 15Ω
Output Resistance	350± 3Ω
Minimum Dead Load	40Lb
V _{min}	0.080Lb
Safe overload (150%)	150% of capacity
Ultimate Overload (300%)	

Wiring Code			
Red	+ Excitation	Black	- Excitation
Green	+ Output	White	- Output

Caution: Cutting cable will affect the Full Scale Output calibration and Voids warranty!

Data obtained utilizing standards traceable to the National Institute of Standards & Technology.

Humboldt Mfg. Co.

Test Report & Data

Linear Displacement Sensor 950Ω Full Bridge balance output

Model **HM-2310.10** Serial No **15869**

Test Results

Test Volts	5.00	Volts Sensitivity @ 25mm	6.880	mV/V
Displacement	25.69 mm	Non Linearity	0.04%	Full Scale

Test data is based on best fit line (worst case for error)

Input volts 2-10 AC or DC

Wiring Connections

Excitation	Pin No	Signal	Pin No.
Excitation +	Red 1	Signal +	Green 4
Excitation -	Blue 2	Signal -	Yellow 5

Pin No. - Only when factory fitted with DIN plug

Operational Notes

- The outer case must not be distorted when clamping the sensor, a full diameter clamp is strongly recommended.
- The sensor is not recommended for use in hostile or extreme environments without protection.
- Special tools are required to remove the plunger lip (anvil). This Anvil forms the mechanical stop for the extent of the plunger travel and must only be removed under controlled conditions that prevent the spindle being depressed into the body of the sensor.

Note

Humboldt Mfg. Co
 875 Tollgate Road, Elgin, IL 60123, USA
 Fax +1708-456-0137, Email hmc@humboldtmg.com Web www.humboldtmg.com

CIUsers\hmc_2\Documents\Server\Help\g\Production\2010\080_25-1

Once this is complete, click on the Right Arrow in the bottom right-hand corner of the screen to save these settings. You will be taken to Tab 2, Limits.

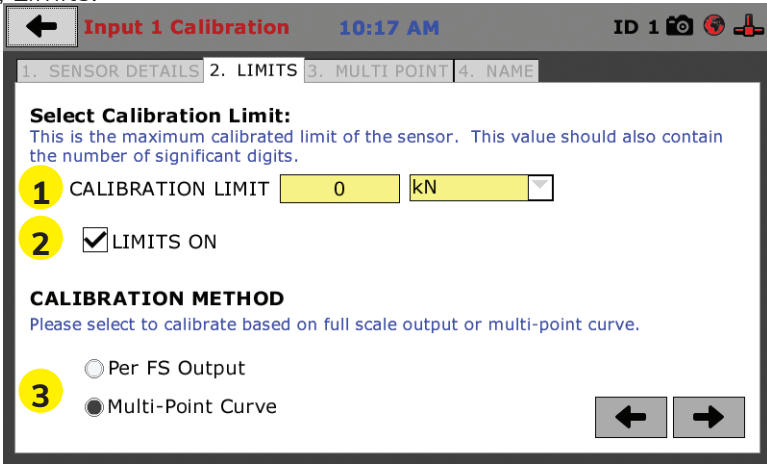

On Tab 2, in the Calibration Limit field **(1)**, enter the maximum calibrated limit of the sensor. This value should contain the number of decimal points you require for degree of accuracy, up to 5 points. Limits On **(2)**, should be checked if you don't want the machine to apply a load greater than the Calibration Limit **(1)**. Calibration Method **(3)** determines whether this calibration will be based only on the maximum load capacity of the sensor or upon a multi-point curve of up to a maximum of 10 points.

If you choose Per FS Output (not a recommended calibration method) it will base your calibration on the maximum load capacity of the sensor vs. zero load capacity of the sensor. If you choose this method and click on the Right Arrow in the bottom right-hand corner of the screen. You will be prompted to remove any load on the sensor and click on Done **(4)** when you have done so.

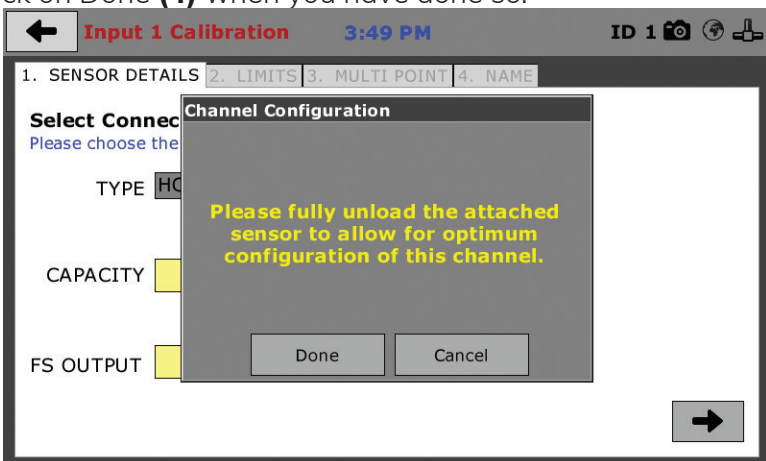

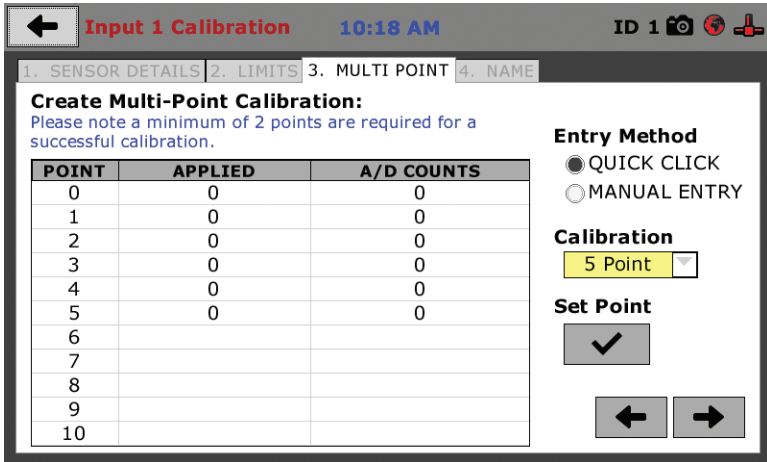

If you choose Multi-Point (Recommended calibration method) Curve and click on the Right Arrow in the bottom right-hand corner of the screen, you will be taken to Tab 3.



On Tab 3 you will be able to set the number of points you want to use for your calibration. You can choose 1-point, 5-point, 10-point or Custom, which allows you to use any number of points up to a total of 10. In the example on the previous screen shot above, a 5-point calibration has been chosen.

With your instrumentation sensor placed in a calibration frame and the sensor plugged into the an Input on the HM-5760. You will set the “0” point at 0 with no load applied to the sensor. The “5” point will be set with the maximum load capacity of the sensor applied. Points “1” through “4” are usually determined by spacing them out evenly between the no load reading and the maximum load reading. As an example, if you have a sensor with a 1,000 lb maximum force capability, you would set the “0” point at “0” and the “5” point at 1,000. Points “1” through “4” would typically be set at: “1” 200; “2” 400; “3” 600; “4” 800 and “5” 1000. Or, divide the maximum load number by the number of points, in this case 5, which works out to 200 point increments between points. See below.

← **Input 3 Calibration** 5:03 PM ID 1   

1. SENSOR DETAILS 2. LIMITS 3. MULTI POINT 4. NAME

Create Multi-Point Calibration:
Please note a minimum of 2 points are required for a successful calibration.

POINT	APPLIED	A/D COUNTS
0	0.00000	834
1	0.40000	40511
2	0.80000	79998
3	1.20000	107513
4	1.60000	837
5	2.00000	191003
6		
7		
8		
9		
10		

Entry Method
 QUICK CLICK
 MANUAL ENTRY

Calibration
 5 Point



Set Point
 1

← →

Each point would be chosen by clicking on the corresponding point row above. The load would be applied to the sensor and an A/D Counts reading would appear. To set the point, click on the Set Point button **(1)**. This would be repeated until all points have been set. In the example above, Point 3 is being calibrated and is ready to have the Set Point button **(1)** clicked. Point 4 still needs to be calibrated.

Once all Points have been calibrated, click on the Right Arrow in the bottom right-hand corner of the screen. You will be taken to Tab 4.

On Tab 4, you will be asked to name the calibrated Input.

← **Input 3 Calibration** 3:23 PM ID 1   

1. SENSOR DETAILS 2. LIMITS 3. MULTI POINT 4. NAME

Select Input Name:
Please create a name for the input (Max 25 characters).

NAME

DEFAULT NAME [INPUT 3 VERT DISP]

←  **1**

The screen will provide a default name, but you can name the Input anything you'd like. Once you've named the Input, click on the disk icon in the lower, right-hand corner **(1)**. This will save it. Use this method for calibrating any additional Inputs necessary.

Test Setup



Test Setup — Consolidation

To begin a new test, Click on the Menu icon in the top left corner of the screen (1). When you click on this button, you will see a drop-down menu appear, see below. Click on NEW TEST (1).

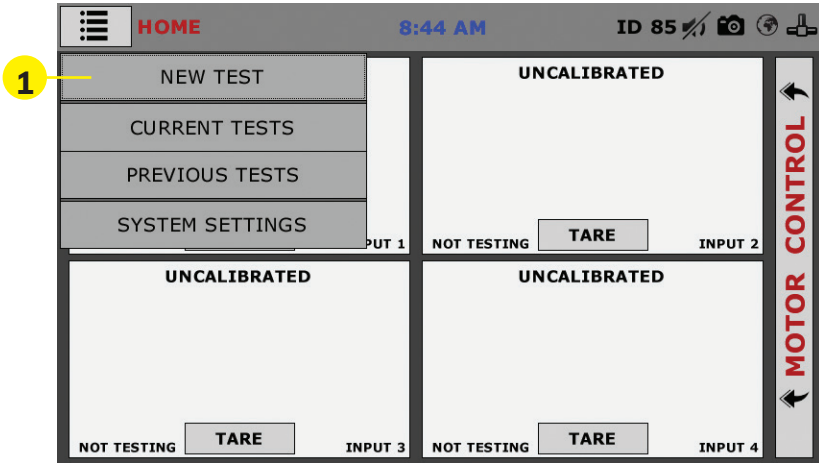

Test Setup Wizard – Select Test Type

Clicking on NEW TEST (1) above brings up the Test Setup Wizard. On the first screen of the Wizard, you can select the type of test you want to perform — Consolidation or Direct Shear (2) and click on the arrow button in the bottom right-hand corner (3)

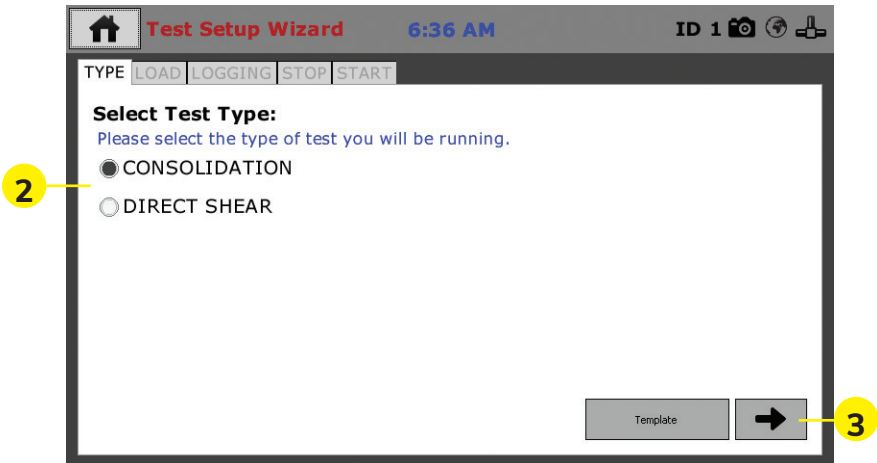

Template

If you are just beginning to use your new machine, there will be no templates, which have been saved, so at this point, clicking on the template button will provide no templates to choose from. To create templates, you essentially save a completed test as a template. Once you have completed some tests and save them as templates, they will then show up when you press the template button. This

can allow you to quickly repeat tests with the same parameters, as well as a fast way to create new tests by choosing a template and then changing some of the parameters.

Test Setup Wizard – Setup Target Load

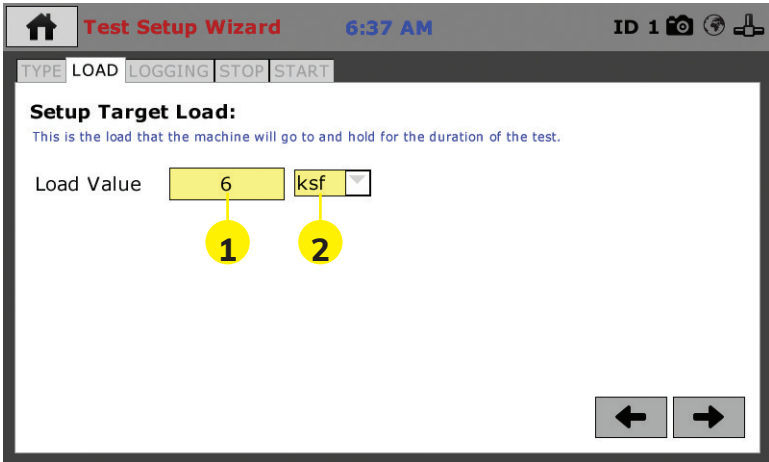

In the previous screen, we chose Consolidation for the Test Type, so this value is the Load Value for a consolidation test. Click on the Load Value field **(1)** and a pop-up menu will appear. Use this menu to type in the value you want to use for the Load Value. Click the check mark in the lower right-hand corner of this pop-up menu to choose the value and you will be returned to the screen above. You can then choose the type of unit by clicking on the right-side pop-up field **(2)**. Your choices here are: kN, lbf, kPa and ksf. Choose one, and, to continue, press the Right Arrow in the lower, right-hand corner of the screen (3).



When you click on the Right Arrow in the lower, right-hand corner of the screen (3). You will get a pop-up window asking if this is the first load sequence of a new specimen, as shown below.

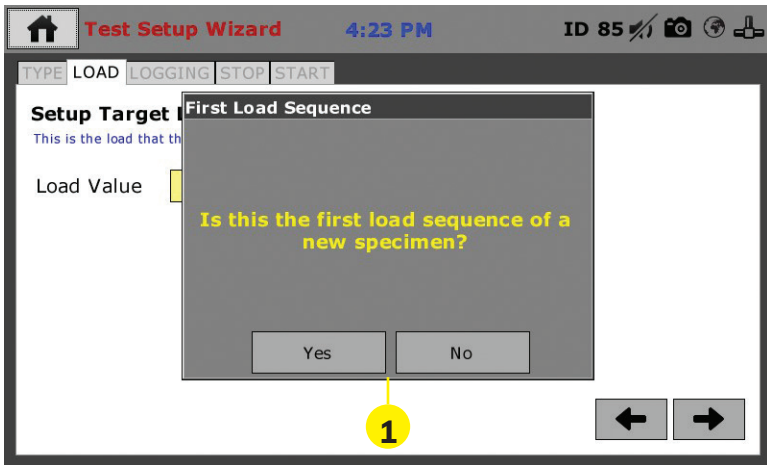

Choose Yes or No. (1). You will see the screen below. if you choose yes, the vertical displacement will be tared (zeroed) at the beginning of the test.

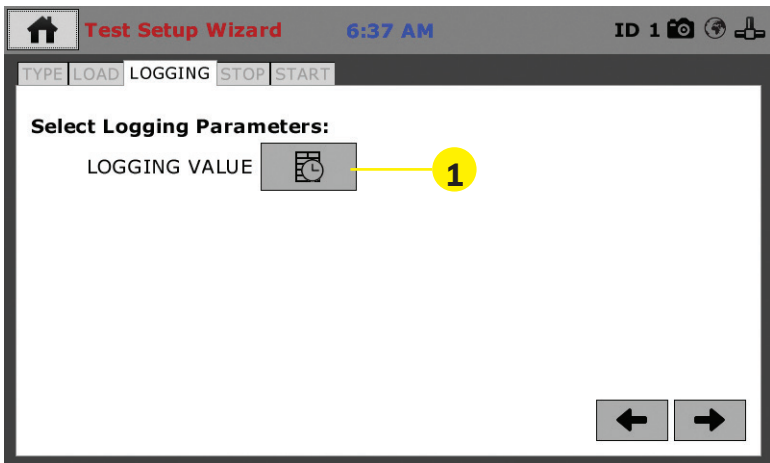

Test Setup Wizard – Select Logging Values

Click on the Logging Value Icon (1). A new pop-up window will appear entitled Logging Time Table, see below.

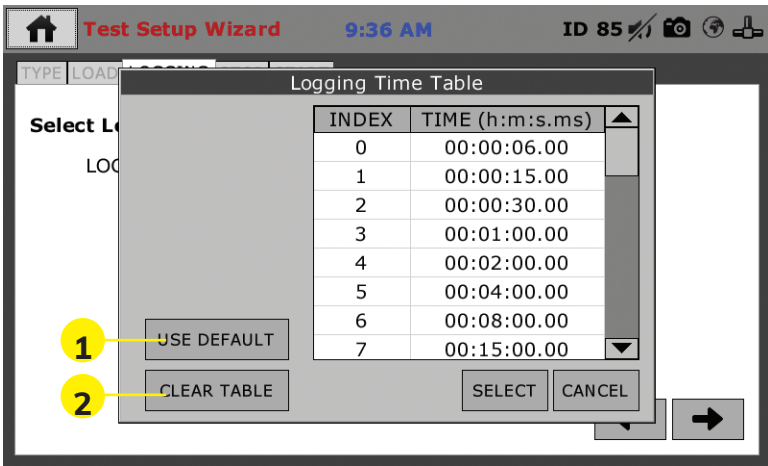

For most people, who are following ASTM D2435, BS:1377:5, AASHTO T216, UNE 103-405, if you choose yes the vertical displacement will be tared (zeroed) at the beginning of the test testing procedures, click on Use Default **(1)** and the machine will fill in the Time Table per the ASTM standard.

For those who want to use different parameters, you can either click on Use Default **(1)** and change the values to suit your application, or, click on Clear Table **(2)** and fill in the blank table with your values.

Once you are satisfied with the completed table, click on the Select button (3) to use the Table. You will be returned to this screen.

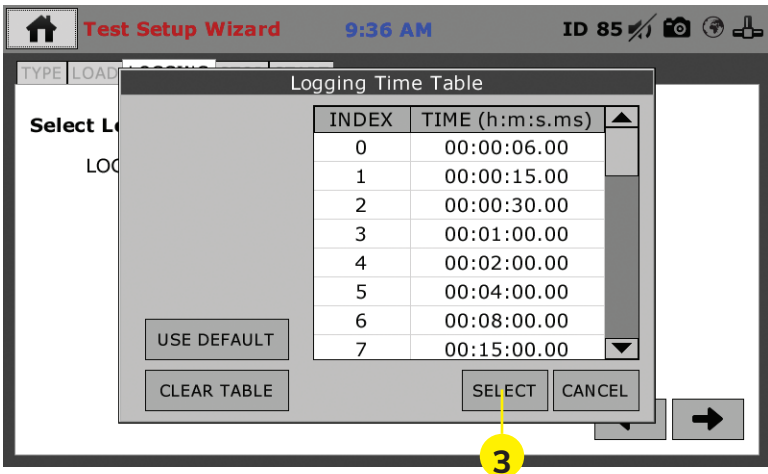

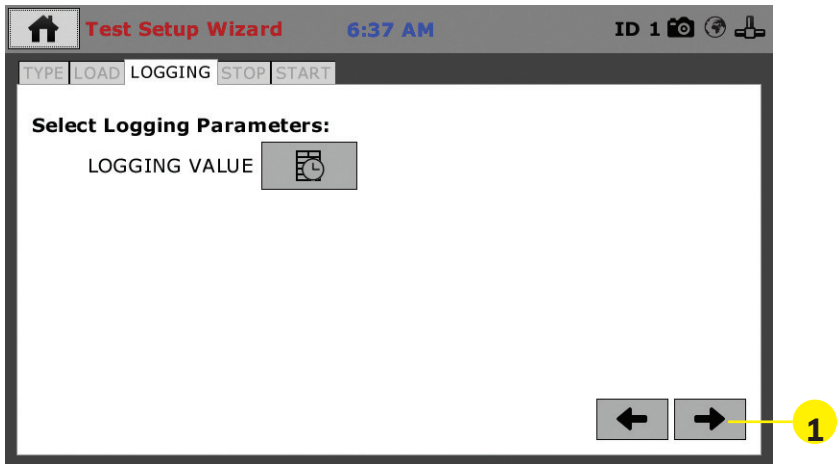

To continue with your chosen values, click on the Right Arrow **(1)** in the lower right-hand corner.

Test Setup Wizard – Select Stop Parameters

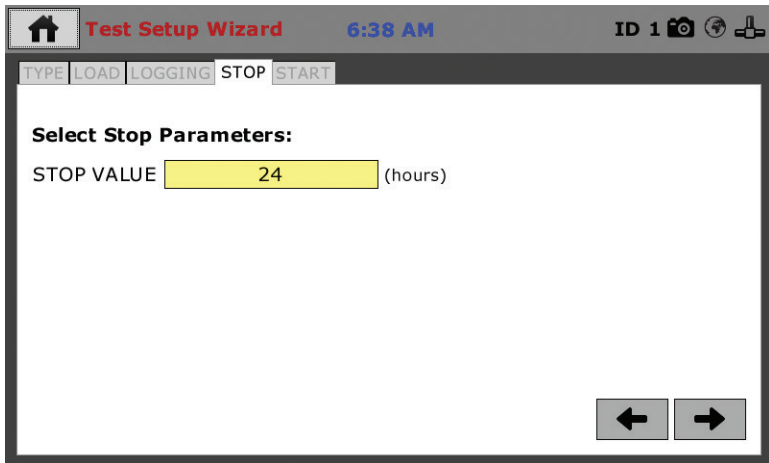

Next you need to select the Stop Parameters for the test. To choose the Stop Value Parameter, Click on the yellow field and select a time period from the pop up window that appears.

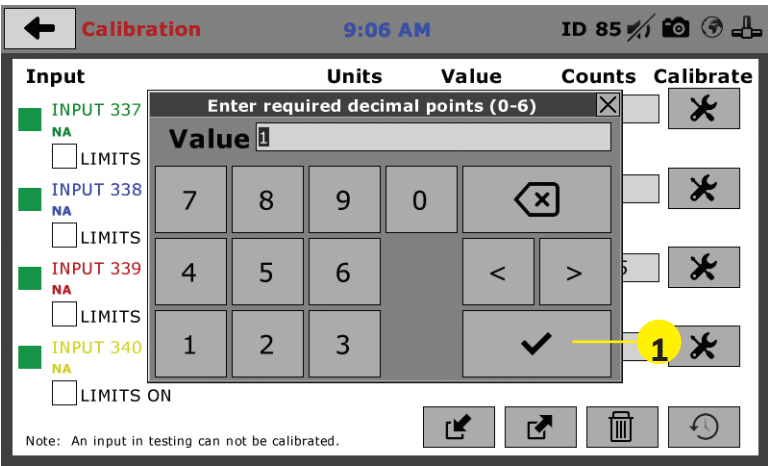

To save your Stop Value, click on the check mark **(1)** in the lower, right-hand corner of the pop up window. You will return to the original screen.

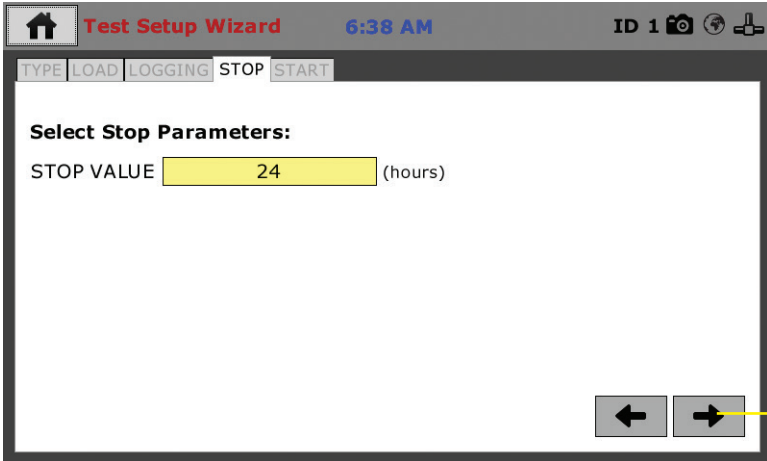

To proceed, click on the Right Arrow in the lower, right-hand corner of the screen.

Test Setup Wizard – Select Trigger Parameters (Start Tab)

On this screen (see below), if you have attached instrumentation for a consolidation test and it has been calibrated, that device should show up automatically in the Trigger Input field **(1)**. The Trigger Value **(2)** and Current Value **(3)** should also be automatically filled in for that device. The automatic Trigger Value will always read slightly lower than the Current Value. In this case, by default, the Trigger Value is automatically set .002 lower than the Current Value. If you choose, you can manually alter the Trigger Value here.

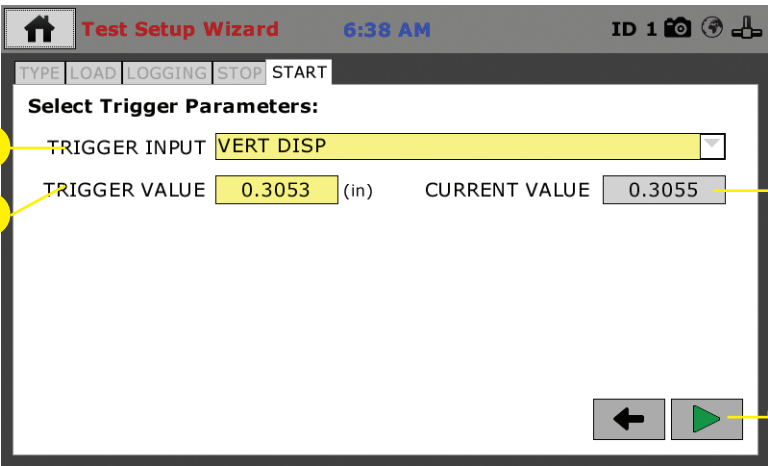

Once completed, press the Green Arrow at the bottom right-hand corner of the screen (4). You will then see the screen below.



In the Value Field, create a name for your test (1). Press the check mark button (2) to save your test name. You will hear an extended beep sound indicating your test name has been saved. You will be taken to the Current Test Screen (below) and your test will begin automatically.

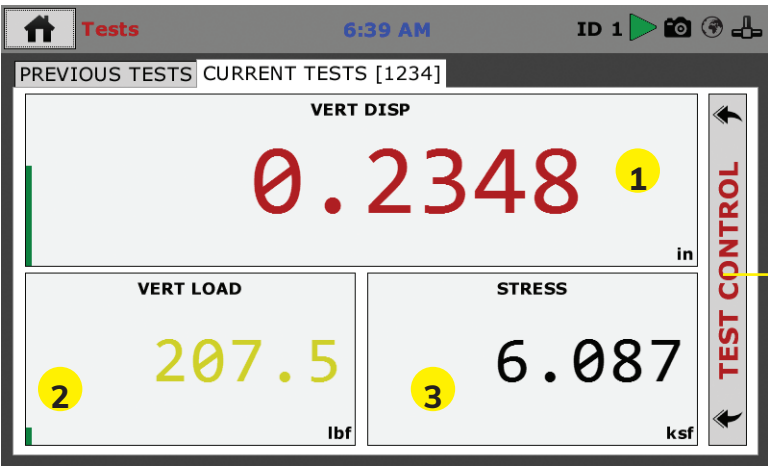

You can monitor your test from this window, which allows you to view the Vertical Displacement (1), the Vertical Load (2) and the Stress (3), or for additional information, click on the Test Control bar on the right of the window (4), which will reveal the additional panel shown below.

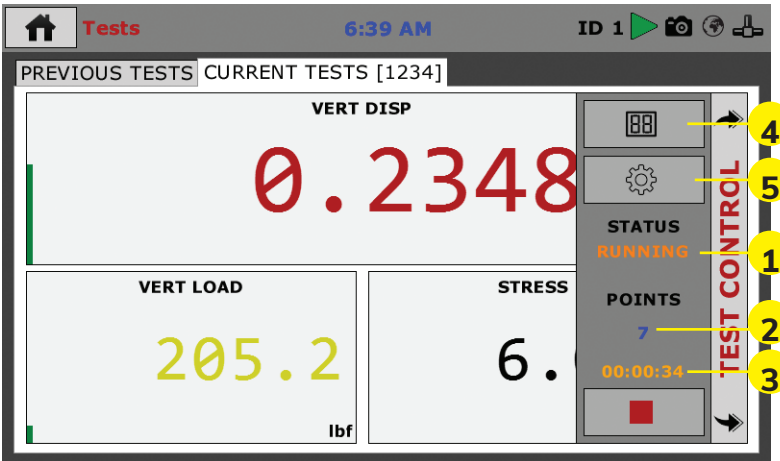

From this new panel you are given the Current Status of your test, in this case, Running (1). You can also see the number of points currently read (2) and the current duration of the test (3).

In addition, by clicking on the Test View button (4) you can toggle through three different views of the current test. These views are:

Selection View

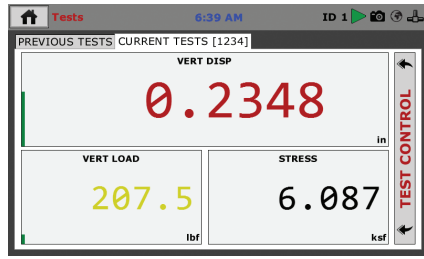

Graph View

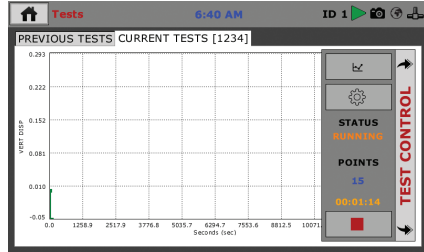

Tabulation View

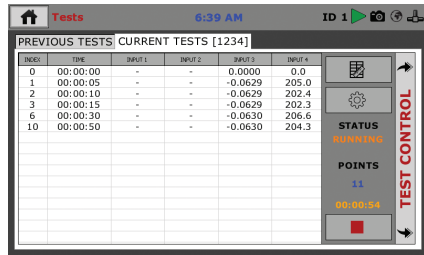

By clicking on the Test selection button (5) when you also have the Current Tests tab selected, you can view all currently running tests.

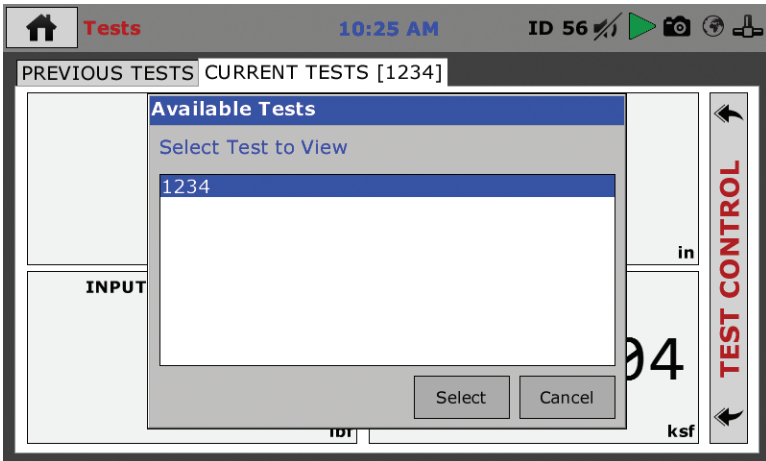

Choosing a test from the list of currently running tests, allows you to monitor that test in all views. This allows you to view the status of all your running tests one at a time.

Test Setup — Direct Shear

To begin a new test, Click on the Menu icon in the top left corner of the screen (1). When you click on this button, you will see a drop-down menu appear, see below. Click on NEW TEST (1).

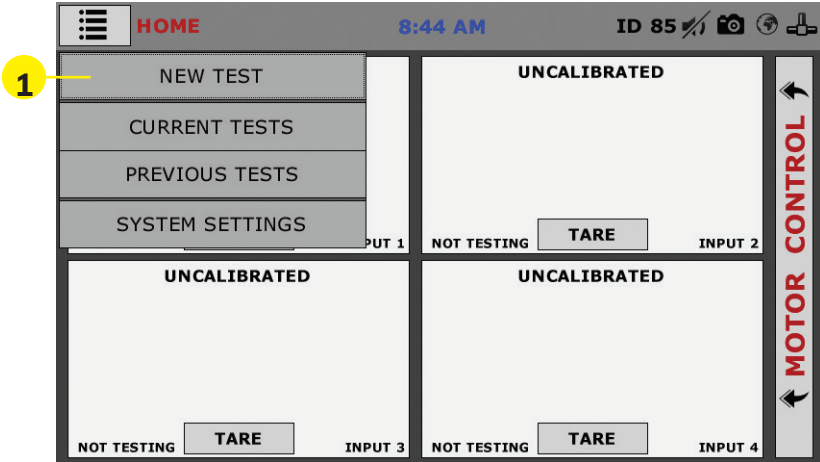

Test Setup Wizard – Select Test Type

Clicking on NEW TEST (1) above brings up the Test Setup Wizard. On the first screen of the Wizard, you can select the type of test you want to perform — Consolidation or Direct Shear (2) and click on the arrow button in the bottom right-hand corner (3)

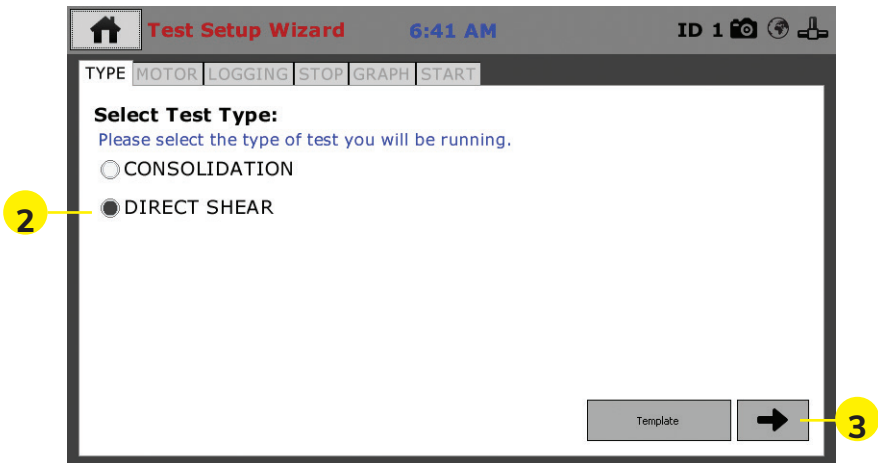

Template

If you are just beginning to use your new machine, there will be no templates, which have been saved, so at this point, clicking on the template button will provide no templates to choose from. To create templates, you essentially save a completed test as a template. Once you have completed some tests and save them as templates, they will then show up when you press the template button. This 51

can allow you to quickly repeat tests with the same parameters, as well as a fast way to create new tests by choosing a template and then changing some of the parameters.

Test Setup Wizard – Select Motor Condition

Test Setup Wizard 6:41 AM ID 1

TYPE MOTOR LOGGING STOP GRAPH START

Select Motor Condition:
Please choose the speed for testing. The use of motor is not required.

NO MOTOR CONTROL
 MOTOR CONTROL

Select Motor Parameters:

1 DIRECTION

2 SPEED in/min

3 RETURN HOME

← →

On this screen you need to select a Motor Condition. In almost all applications you will choose Motor Control. When Motor Control is selected, the Motor Parameters choices appear. Direction (1) choose either Right or Left Motor Direction. Next, enter a Speed (2).

Test Setup Wizard 10:17 AM ID 56

TYPE MOTOR LOGGING STOP GRAPH START

Select Motor
Please choose the
 NO MOTO
 MOTOR C

Select Mote
DIRECTION
SPEED

RETURN HOME

← →

Set Motor Speed

Value

7	8	9	0	⌫
4	5	6	.	< >
1	2	3		✓

When you click on the Speed field a value picker will open. Type in a speed and click on the Check box in the lower, right-hand corner of the picker to select. You can also check the Return Home check box (3) if you want the machine to return to the Home position after the test. Once completed click on the Right Arrow in the lower, right hand corner of the screen, to continue.

Test Setup Wizard – Select Logging Parameters

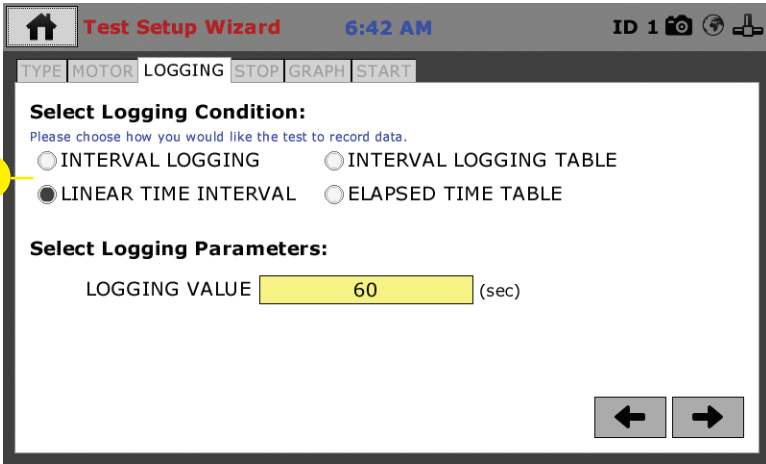

For Logging Condition **(1)**, you have four (4) choices: Interval logging, Linear Time Interval Logging Table and Elapsed Time Table. Choose the one that best fits your application needs. In this example Linear Time Interval has been chosen and to complete this setup, a logging value must be entered into the Logging Value field. Click on the field and a pop-up window will appear. Enter the value and click on the check mark in the lower, right-hand corner of the window to save.

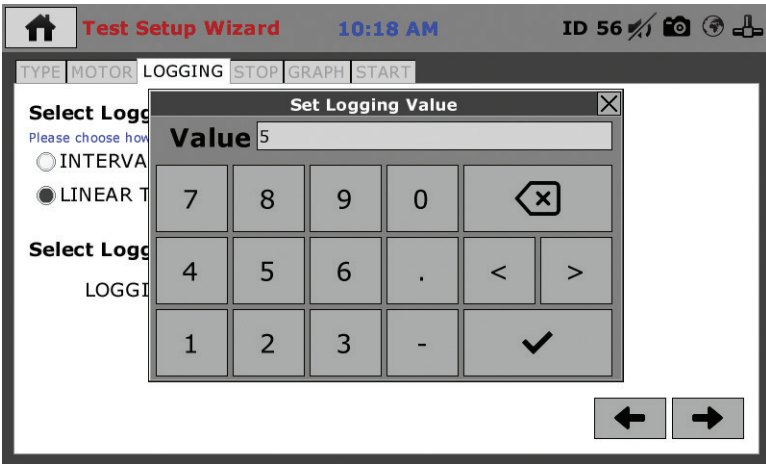

Test Setup Wizard – Stop Conditions

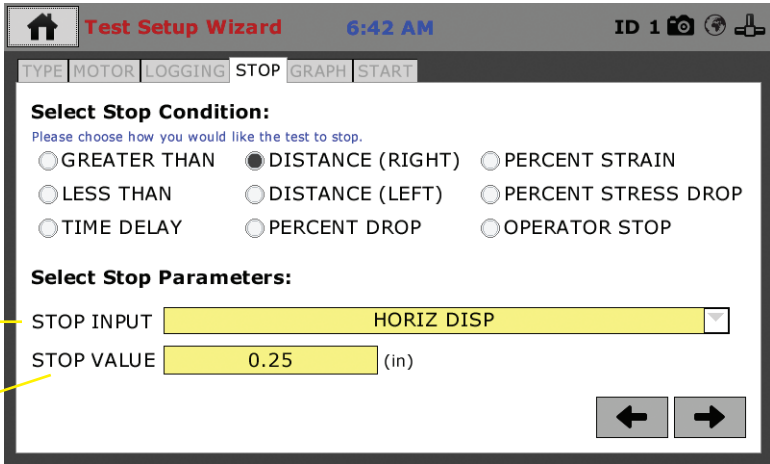

To set the Stop Condition for your test, select one condition from the list of nine (9). Distance (Right) has been chosen for our example here. Then choose the appropriate input device to coincide with your choice from the Stop Input field **(2)**. Also, add a value in the The Stop Value field **(3)**, by clicking on it and using the pop-up window to enter a value. Click the Check Mark in the lower right-hand corner to save the value.

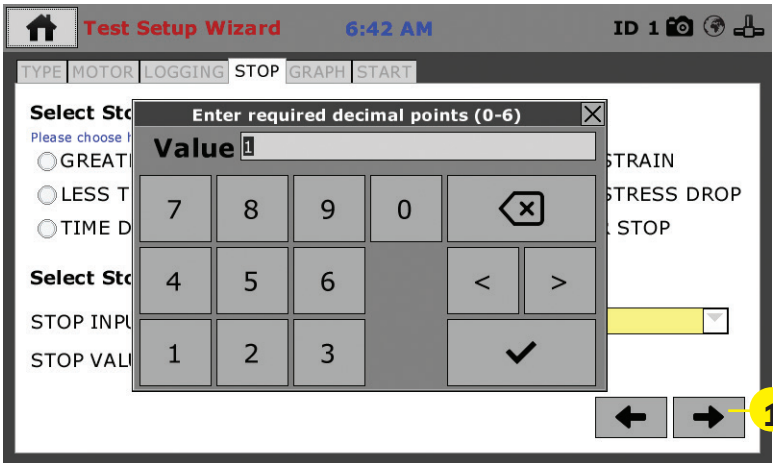

Click the Arrow **(1)** in the lower, right-hand corner of the window to continue the Setup process.

Test Setup Wizard – Graph Conditions

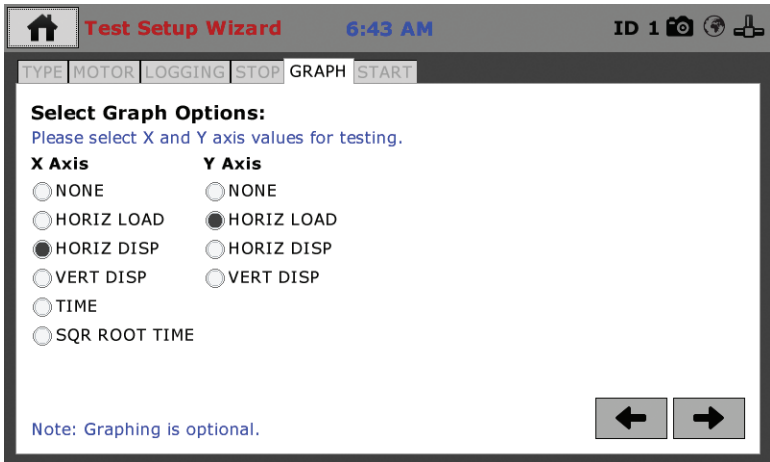

To set the Graph Options for your test, select one option for the X and one option for the Y axis from this list. In our example here the Horiz Disp and Horiz Load have been chosen. Then choose the appropriate input device to coincide with your choice from the Stop Input field **(2)**. Also, add a value in the The Stop Value field, by clicking on it and using the pop-up window to enter a value. Click the Check Mark in the lower right-hand corner to save the value.

Operation from a Computer and NEXT Software

This manual covers the setup and operation of the HM-5030.3F Load Frame in Stand-alone Mode only. For information on operating your load frame with Humboldt's NEXT Software and a computer, please refer to the Humboldt NEXT software manual.

HM-5760.3F Specifications

The Humboldt HM-5760 Direct/Residual Shear apparatus is a fully-automated system utilizing pneumatic loading to apply vertical loads to a sample eliminating the need for loading weights used in dead weight-type systems.

The microprocessor-based system features a stepper-motor drive system and a 7" touch-screen display that allows the operator to control and monitor all test functions.

Like all Elite Series machines, the HM-5760 is built around Humboldt's integral, 4-channel data logger with touch-screen control, which allows the HM-5760 to be used as a standalone device capable of full test control and data logging. It can also be controlled by a networked computer at any location with access to the network.

The HM-5760 is supplied complete with two 2,000 lbf (10kN) capacity load cell; 1" (25.4mm) horizontal strain transducer, a 0.4" (10.2mm) vertical strain transducer and Humboldt's NEXT Direct Shear software module. Shear box assemblies and related accessories are not included and should be ordered separately.

HM-5760.3F Specifications:	
Horiz. movement	2" (50mm) Maximum
Horiz. shear force	2000 lbf (10kN)
Vertical load	2000 lbf (10kN)
Data Channels	4
Speed Range	0.00001 to 0.49999 in./min. 0.00001 to 12.9999 mm/min.
Data storage	1000 tests and up to 3000 readings per test
Dimensions (L x D x H)	30" x 15.5" x 22" (760 x 394 x 558mm)
Voltage	110/220V 50/60Hz - 6.5amps

Controller Specifications:

Display (Resistive Touch)	7" (178mm) VGA (480 x 800)
Real-time test data	Graphic and tabulation
Processor	Dual 32-bit ARM
RAM	64MB
Memory, non-volatile	4GB
Analog to digital converter	24 bit
Data acquisition	4 Channels
Logging speed	up to 50 readings per second
Multi-test storage	1000
Points per test	3000
USB port (front)	export data, import/export calibration data, WiFi
USB port (back)	provides external power for wireless access point
Ethernet connection	for network connectivity
Emergency stop	Large button
24-bit differential analog to digital converter	4
Ambient temperature sensor	1
Limit switches	2
Firmware Update	Ethernet or flash drive

General Warnings

Keep body parts clear of moving surfaces when operating machine. Ensure all motion has stopped prior to adding or removing testing samples or support equipment.

Safety Warnings

Operators should take care to operate this machine under maximum load restrictions. The machine is programmed at the factory to provide safety shutdown if the upper or lower maximum travel is exceeded, as well as if the upper instrument calibration is exceeded.

Electrical Warnings

Typically, there is no reason for the operator to open the machine. However, if the customer's engineers attempt to change settings to the circuit board connected to the back panel, the machine must first be unplugged. Unplugging the internal connection to the back panel circuit board while the machine is under power will result in permanent damage to the circuit board.

Important Notice

The information contained herein is supplied without representation or warranty of any kind. Humboldt Mfg. Co. therefore assumes no responsibility and shall have no liability, consequential or otherwise, of any kind arising from the use of the described equipment contained in this manual.

Updated Products

The manufacturer reserves the right to change or modify product design or construction without prior notice and without incurring any obligation to make such changes and modifications on products previously or subsequently sold.

Fitness for Application

The manufacturer makes no recommendations or claims regarding fitness for applications other than the specific tests as defined in this User Guide.

Unpacking

Initial inspection should include checking for physical damage during shipping and obvious external damage to the product.

Package contents are defined by your packing list. Each Loader is configured according to customer specifications. In your inspection, make certain that the contents of your shipment match the documentation provided by your packing list.

Place unit on a flat, smooth surface and use leveling feet (supplied) and a bubble level to ensure that the unit is level side-to-side and back-to-front.

Warranty

Humboldt Mfg. Co. warrants its products to be free from defects in material or workmanship. The exclusive remedy for this warranty is Humboldt Mfg. Co., factory replacement of any part or parts of such product, for the warranty of this product please refer to Humboldt Mfg. Co. catalog on Terms and Conditions of Sale. The purchaser is responsible for the transportation charges. Humboldt Mfg. Co. shall not be responsible under this warranty if the goods have been improperly maintained, installed, operated or the goods have been altered or modified so as to adversely affect the operation, use performance or durability or so as to change their intended use. The Humboldt Mfg. Co. liability under the warranty contained in this clause is limited to the repair or replacement of defective goods and making good, defective workmanship.

Manufacturer's Rights and Responsibilities Software Copyright

COPYRIGHT NOTICE

©2016 HUMBOLDT Mfg. Co. All Rights Reserved. This manual or parts thereof may not be reproduced in any form without the expressed written permission of HUMBOLDT Mfg. Co.

UNPUBLISHED LICENSED PROPRIETARY WORK

©2016 HUMBOLDT Mfg. Co.

The programmable, read-only memory, integrated circuit package contained in this equipment and covered with a copyright notice label contains proprietary and confidential software, which is the sole property of HUMBOLDT MFG. CO. It is licensed for use by the original purchaser of this equipment for a period of 99 years. Transfer of the license can be obtained by a request, in writing, from HUMBOLDT MFG. CO.

With the exception of HUMBOLDT Authorized Service Facilities, you may not copy, alter, de-compile, or reverse assemble the software in any fashion except as instructed in this manual. US copyright laws, trademark laws, and trade secrets protect the materials. Any person(s) and /or organizations that attempt or accomplish the above violation or knowingly aid or abet the violation by supplying equipment or technology will be subject to civil damages and criminal prosecution. With the exception of HUMBOLDT Authorized Service Facilities, you may not copy, alter, de-compile, or reverse assemble the software in any fashion except as instructed in this manual. U.S. copyright laws, trademark laws, and trade secrets protect the materials.

Any person(s) and /or organizations that attempt or accomplish the above violation or knowingly aid or abet the violation by supplying equipment or technology will be subject to civil damages and criminal prosecution.

Humboldt Mfg. Co.
875 Tollgate Road
Elgin, Illinois 60123 U.S.A.

U.S.A. Toll Free: 1.800.544.7220
Voice: 1.708.456.6300
Fax: 1.708.456.0137
Email: hmc@humboldtmfg.com

